



fiamma.com

**Bicycles carrier**

**EN**

Installation and  
usage instructions

**Porte-vélos**

**FR**

Instructions de montage et  
mode d'emploi

**Portabicicletas**

**ES**

Instrucciones de montaje y uso

## **CARRY-BIKE® AIRSTREAM**



**Carry-Bike**

**EN** Package contents  
**FR** Contenu de l'emballage  
**ES** Contenido del embalaje

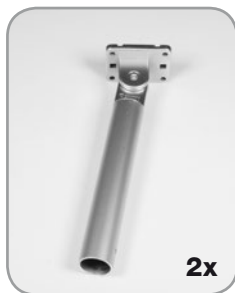
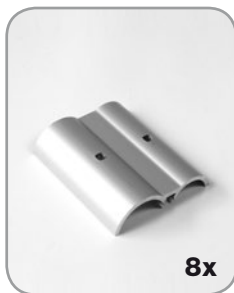

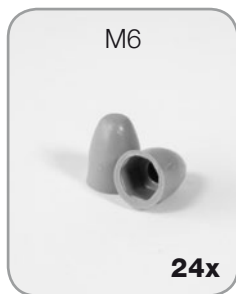
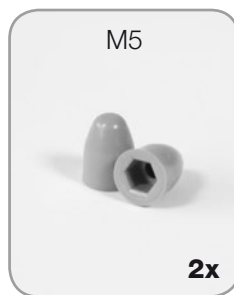
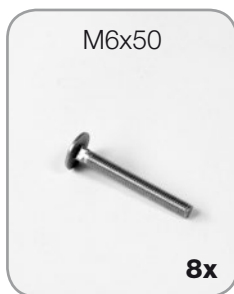
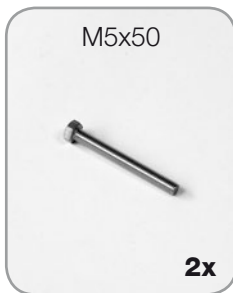
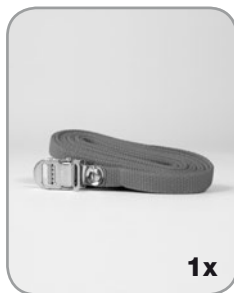

**EN** Goods receipt inspection

**FR** Contrôle à la réception

**ES** Control al recibimiento

**EN** Check that nothing has been damaged or deformed during transport.  
In case of damage please contact the dealer.

**FR** Contrôler qu'aucune pièce ne soit cassée ou déformée suite au transport.  
En cas contraire, contacter le revendeur.

**ES** Controlar que ningún detalle se haya roto o deformado durante el transporte.  
En este caso contactar al revendedor.

**EN** Installation instructions

**FR** Instructions de montage

**ES** Instrucciones de montaje

**EN** To use the bike carrier in the best way, read the user's instructions carefully and keep them to hand for future consultation.

**FR** Pour tirer le meilleur parti de votre porte-vélos, nous vous invitons à lire attentivement les notices d'emploi et à les conserver pour toute consultation ultérieure.

**ES** Para usar el portabicicletas en lo mejor de los modos, os invitamos a leer atentamente las instrucciones de uso, guardándolas en caso de necesidad.



**EN** **The load on Fiamma bike carriers must be distributed evenly over each of the rails**, eg. a Carry Bike Pro rack if carrying 60kg of weight should have 15kg weight on each of the four rails.

**FR** **La charge maximale des porte-vélos Fiamma doit être répartie équitablement sur chaque rail.** Par exemple, le Carry-Bike Pro qui supporte 60 kg de charge maximale doit répartir 15 kg de charge pour chacun des 4 rails.

**ES** **La carga máxima del Carry-Bike Fiamma se debe distribuir adecuadamente sobre cada canalina.** Por ejemplo en el caso del Carry-Bike Pro con carga máxima de 60 kg tiene que dividirla en 15 kg por cada una de las 4 canalinas.

1

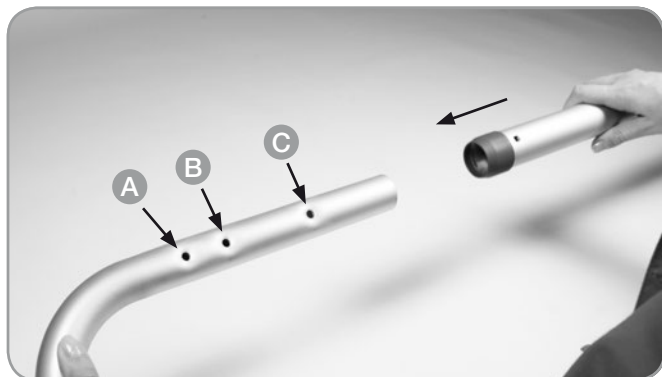

- A** for lower brackets distance = 59"
- B** for lower brackets distance = 61,50"
- C** for lower brackets distance = 67,19"

lower brackets distance



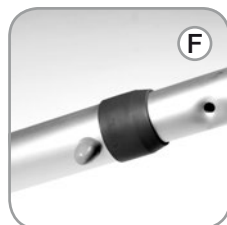
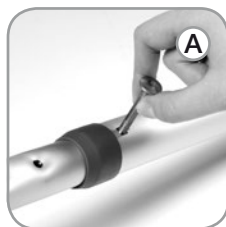
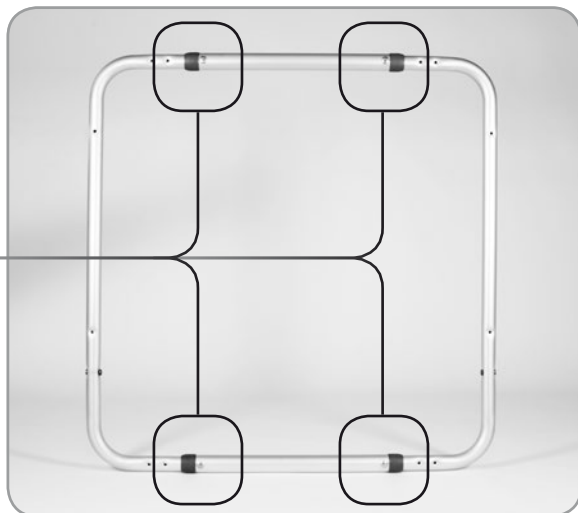

1x

3

Set rack width accordingly to main structure as in step 1 (if necessary)

- A** for lower brackets distance = 59"
- B** for lower brackets distance = 61,50"
- C** for lower brackets distance = 67,19"

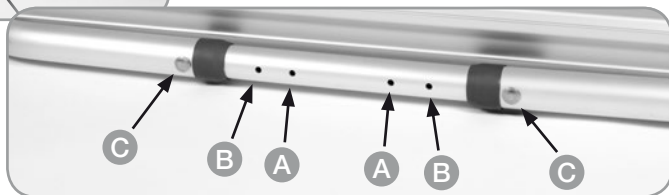

Set both sides at the same position

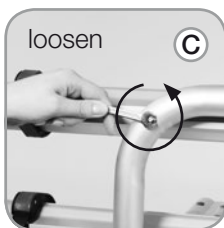
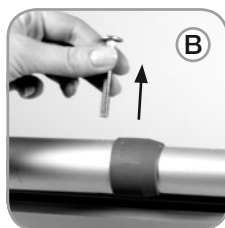
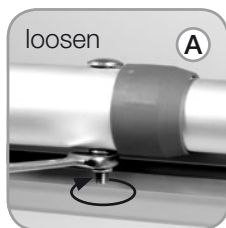

Adjust the rack sliding both sides to the chosen position

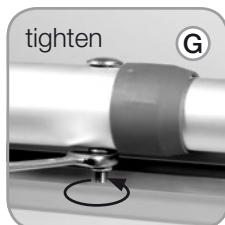

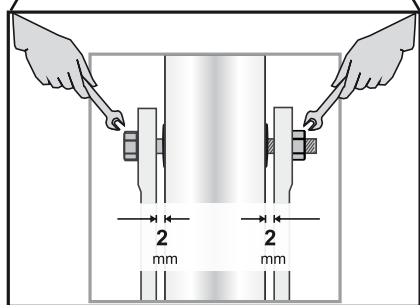
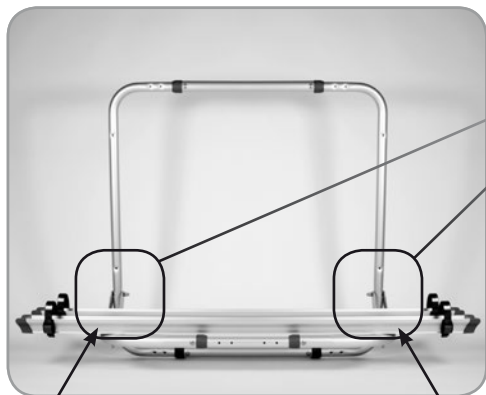

4

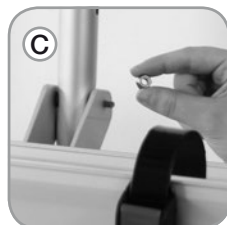
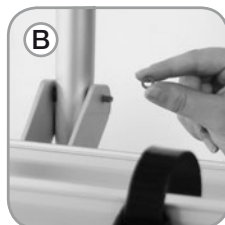

**EN**

**WARNING!** DO NOT FULLY TIGHTEN THE FORK TO THE TUBE! (LEAVE 2 mm SPACE)

**FR**

**ATTENTION!** VEILLEZ A NE PAS SERRER COMPLETEMENT LA FOURCHETTE AU TUBE (LAISSER 2 mm D'ESPACE)

**ES**

**ADVERTENCIA!** NO APRETAR TOTALMENTE LA HORQUILLA AL TUBO! (DEJAR 2 mm DE ESPACIO)

**EN**

Insert the screws so that the cap is turned toward the **inside** on both sides.

**FR**

Introduire les vis de façon à ce que le cache-vis soit orienté vers l'**intérieur** des deux côtés.

**ES**

Insertar los tornillos de manera que el tapón esté dirigido hacia el **interior** en los dos lados.



5

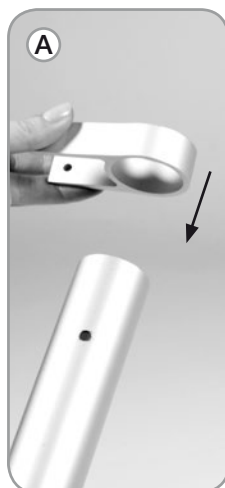

6

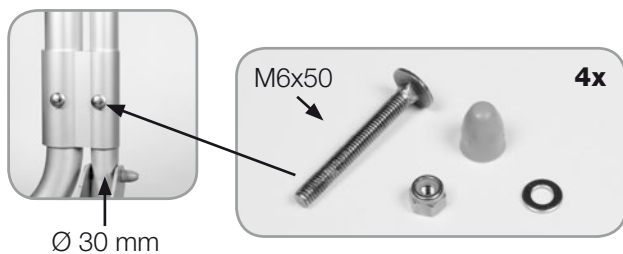
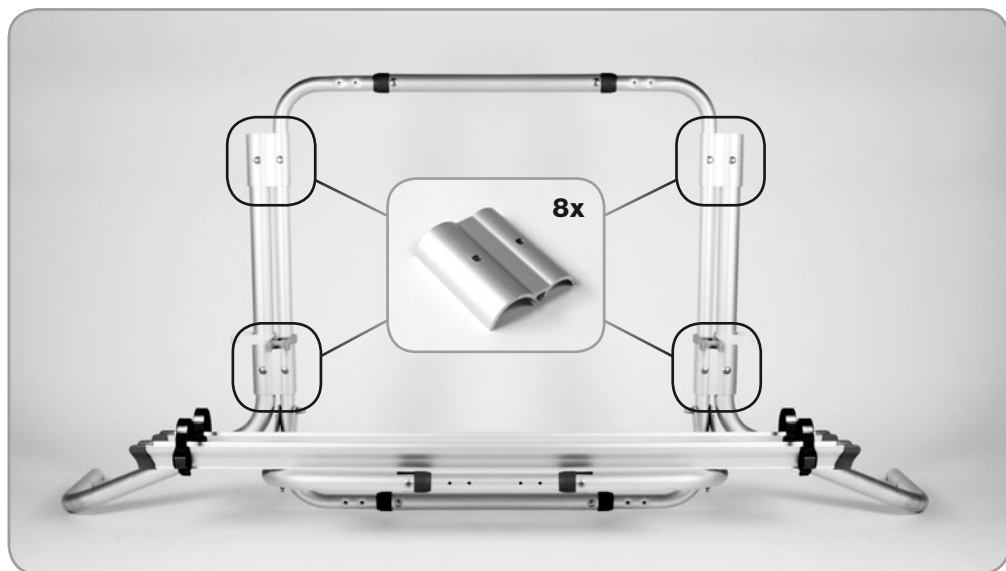
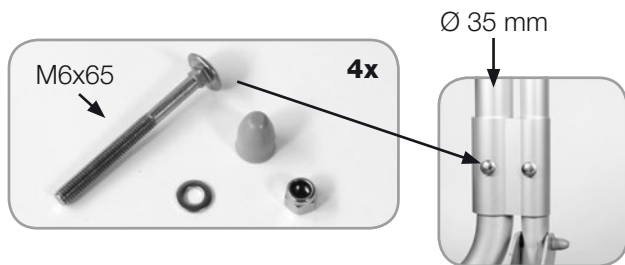



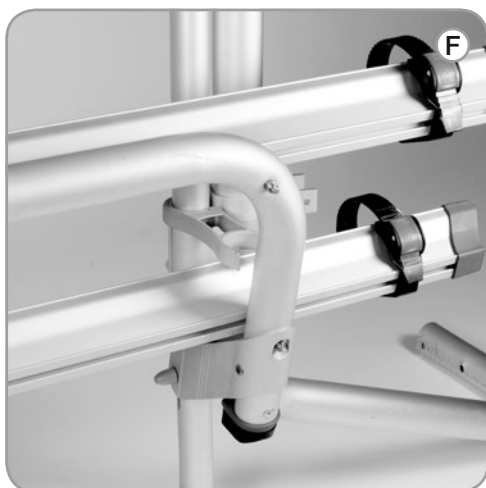
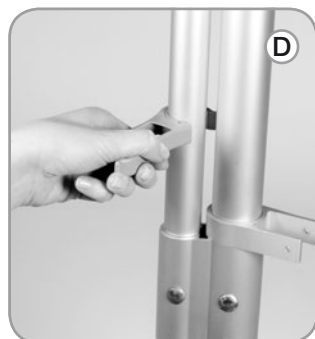
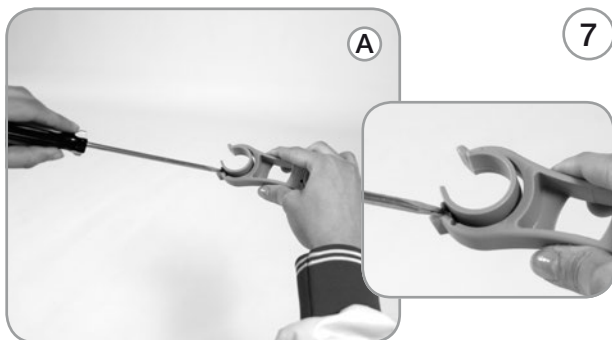



8

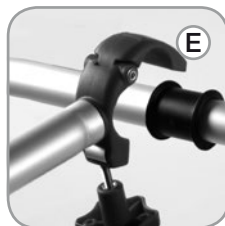
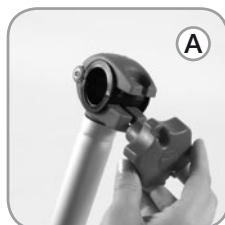

9



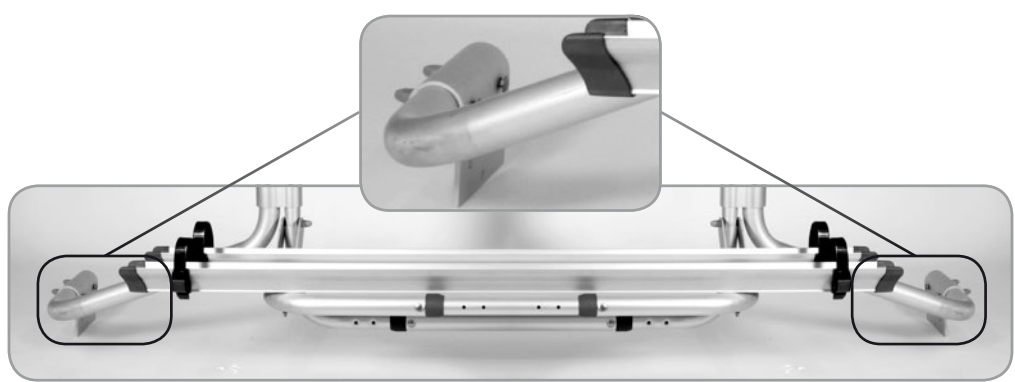

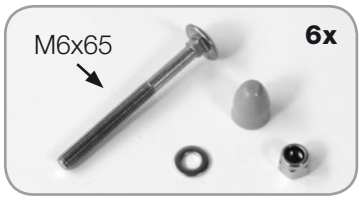

Choose the screws set that suits the caravan structure best

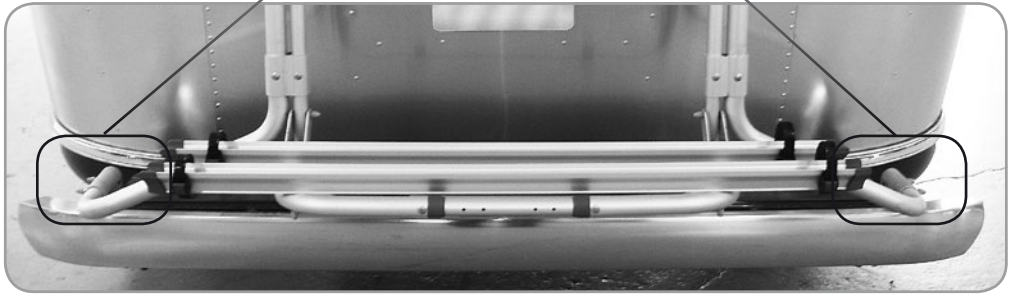

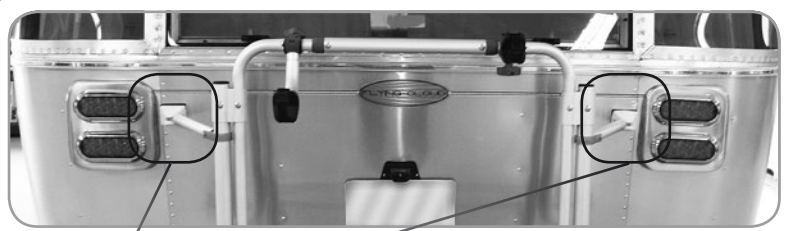

If necessary shorten pipe  
and make a new hole

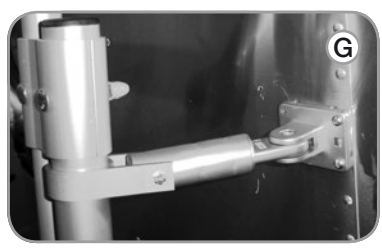

Fasten Carry-Bike to caravan  
(screws not included)



13

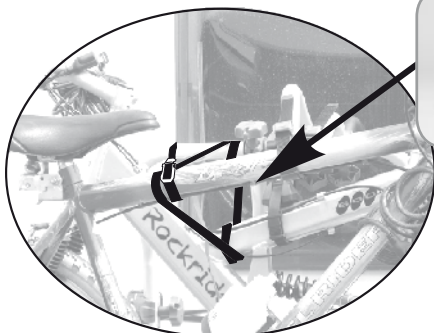

1x

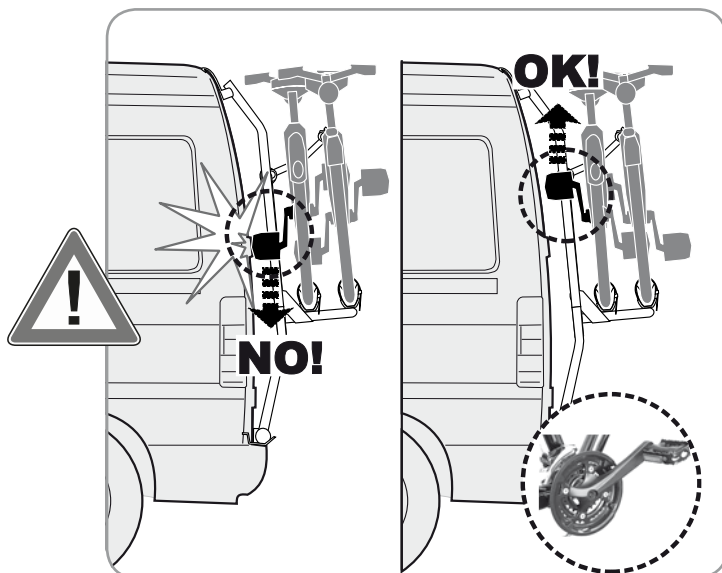

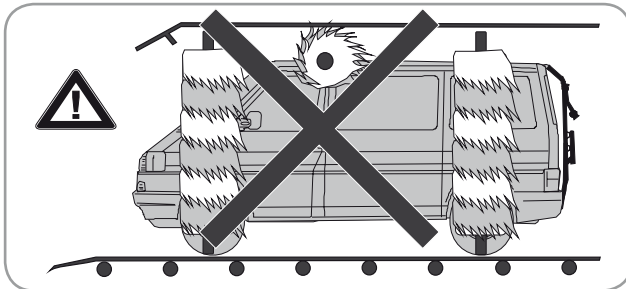
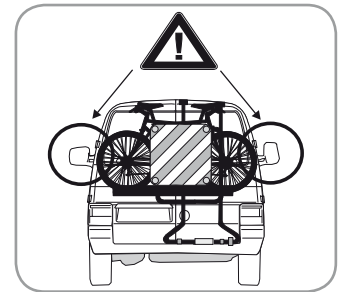
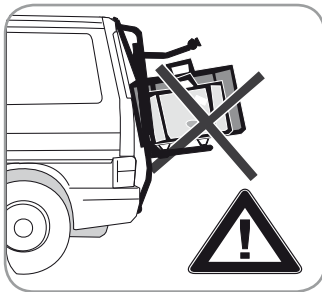
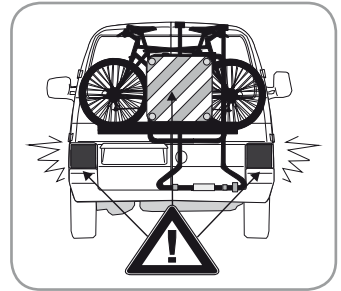
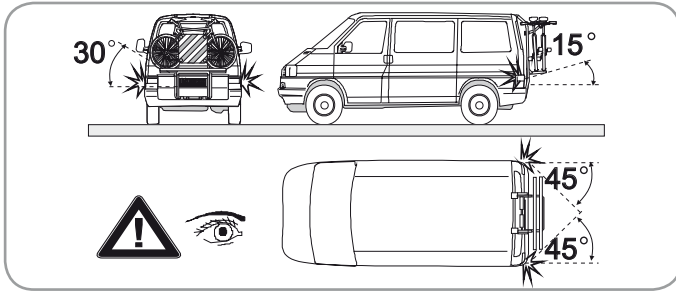
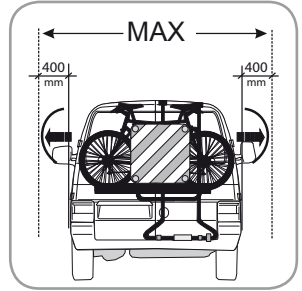
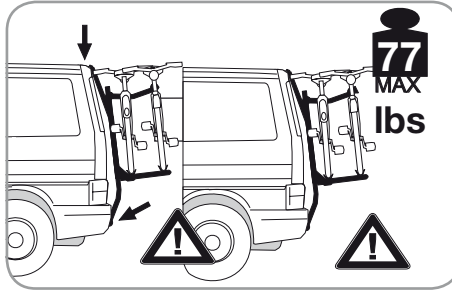
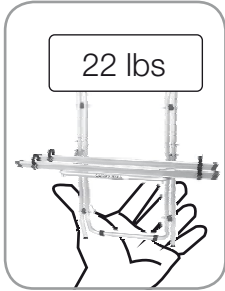

- The FIAMMA Carry-Bike Airstream is a bicycle carrier for caravan that carries 2 bicycles, which should not exceed the total weight of 77 lbs.
- Fasten the Carry-Bike to the rear bearing structure of the vehicle.
- Because it is overhanging structure posteriorly installed, this overhang must be regulated according to the regulations in force.
- The bicycles must be fastened with the specially provided straps.
- We recommend that the area where the bicycle rack will be mounted be cleaned before installation.
- Make sure that the luggage compartment is always closed.
- Make sure that the support brackets are located where they cannot move or shift sideways. They also must not touch the roof of the vehicle, the hinges and the corresponding bolts or screws.
- Periodically check the bicycle rack to make sure it is firmly attached, especially after the first 10 km. Make sure the belts are not loose and that the holding brackets have not shifted.
- Make sure that fastening is secure: during each trip, stop and check that the bicycles are securely fastened after the first short run.
- DO NOT COVER THE NUMBER PLATE OR LIGHTS.
- In the case of a long period of disuse, we suggest that you unhook the bike carrier.
- The load must be evenly distributed and must not exceed the maximum width of the vehicle.
- Be careful when driving and beware of gusts of wind. Also keep in mind that you need a longer braking distance.
- In some cases, the bicycle rack interferes with using the rear windscreen wiper. Carefully examine the brush radius before turning on the rear wiper.
- IN CASE OF USE OF THE BIKE CARRIER WITH TOW MAKE SURE THAT THE TOW HOOK IS ALWAYS ACCESSIBLE AND THE CORNER MOBILITY OF THE TOW IS GUARANTEED (VOLUME MEASURING DIN 74058).
- FIAMMA is not liable for damages arising from non-observance of the laws in force, the installation, carriage and maintenance instructions or from incorrect use of the bike carrier.

- Le Carry-Bike FIAMMA Airstream est un porte-vélos pour la caravane, disponible dans la version pour le transport de 2 vélos et ne devant pas excéder le poids total de 77 lbs.
- Le Carry-Bike FIAMMA doit être fixé fermement à la structure portante arrière du véhicule.
- S'agissant de structures en porte-à-faux installées successivement, il est nécessaire de suivre la réglementation en vigueur en la matière.
- Les vélos doivent être attachés avec les sangles spécialement conçues à cet effet.
- Vérifier que le coffre à bagages soit correctement fermé.
- S'assurer que les supports de fixation sont positionnés dans des zones où aucun transfert ou déplacement latéral n'est possible. De plus, ils ne doivent toucher ni le toit du véhicule, ni les charnières, ni les boulons et les vis correspondants.
- Contrôler régulièrement l'état de fixation du porte-vélos, surtout après les 10 premiers kilomètres pour vérifier que les supports de fixation ne se sont pas déplacés.
- Vérifier le bon arrimage des vélos : à chaque voyage, il est conseillé de s'arrêter après avoir parcouru une distance brève pour en contrôler la stabilité.
- **NE CACHER NI LA PLAQUE D'IMMATRICULATION NI LES FEUX.**
- En cas de non-utilisation, il est préférable de décrocher le porte-vélos du véhicule.
- Le chargement doit être distribué de façon homogène et ne doit pas dépasser la largeur maximale du véhicule.
- Au cours des déplacements, faire particulièrement attention aux routes en lacets et aux coups de vents latéraux. Calculer un distance de freinage supérieure.
- **POUR UN USAGE AVEC REMORQUE, VÉRIFIER QUE LE CROCHET D'ATTELAGE SOIT ACCESSIBLE ET QUE LA MOBILITÉ ANGULAIRE DE LA REMORQUE SOIT ASSURÉE (mesure du volume DIN 74058).**
- FIAMMA ne répond pas des dommages dus au non-respect concernant la législation en vigueur, les recommandations d'installation, le transport, l'entretien ou l'usage non conforme qui relèvent de la responsabilité de l'acheteur.

- El Carry-Bike Fiamma Airstream es un portabicicleta para caravana que puede llevar 2 bicicletas, que no superen 77 lbs.
- Es importante instalarlo solidamente en la estructura trasera del vehículo.
- Dado que se trata de estructuras cargas sobresalientes, es necesario regular esta prominencia según la normas vigentes.
- Las bicicletas tienen que estar fijadas con las cinchas correspondientes
- Tener cuidado con que el maletero esté siempre bien cerrado.
- Tener cuidado con que los estribos de fijación del Carry-Bike sean posicionados en puntos donde no sean posibles desplazamientos laterales; no tienen que tocar el techo del vehículo, los tornillos o las cremalleras.
- Controlar periódicamente el estado de fijación del Carry-Bike sobretodo después de los primeros 10 Km, asegurándose que los estribos no se hayan desplazados
- Asegurarse de que la fijación sea firme durante cada viaje, recorrer un breve trecho y luego pararse para controlar la correcta fijación de los portabicicletas.
- **NO CUBRIR NI LA MATRICULA NI LAS LUCES**
- En caso de que no se use, les rogamos desganchar el Carry-Bike del vehículo.
- El cargo tiene que estar distribuído uniformemente y no tiene que superar la anchura máxima del vehículo.
- Durante la conducción poner mucho cuidado con las curvas y con los golpes de viento. Además tenemos que poner mayor cuidado con la distancia de frenazo.
- **ES IMPORTANTE VERIFICAR QUE EN CASO DE USO CON REMOLQUE, PERMANEZCA ACCESSIBLE EL ENGANCHADOR DE VAGONES Y QUE SEA GARANTIZADAS MOVILIDAD ANGULAR DEL REMOLQUE (medidas del volumen DIN 74058).**
- Fiamma no responde a daños por falta de respeto de las normas vigentes, de las indicaciones de instalación, transporte, mantenimiento o uso impropio, que es responsabilidad del adquiridor.

1. FIAMMA Products have a 12 month guarantee from the date the end user purchases the product.
2. The FIAMMA warranty covers claims for damages that are due to defective material or production failures.
3. The warranty is not valid under the following circumstances: natural wear of the product, if proper installation instructions have not been followed, in cases of negligence or improper use, if non original FIAMMA spare parts have been used, if the damage comes from transporting the product with improper packaging not authorised by FIAMMA, in the case of intervention by a non qualified person, or when the end user or anybody else has modified the product without the proper authorisation of FIAMMA.
4. If the claim is covered under warranty, FIAMMA reserves the right to decide whether to repair or replace the covered part(s) determined to be defective.
5. The claim should be submitted to the supplier, from which the product was originally purchased. It is vital to always provide the following information: serial number of the product, proof of purchase (FIAMMA could ask for a copy) and a precise description of the damage (together with some digital photos to help substantiate the claim). In the case of false or incomplete information, FIAMMA reserves the right to refuse the claim.
6. FIAMMA reserves the right to ask for return of the products in order to verify the warranty claim. The cost and risks/insurance of transportation is to be paid by the client. If the warranty request is then verified, FIAMMA will pay for the transport, i.e. cost of sending and returning the part, as well as costs for repairing/replacing the part. If the warranty claim is not accepted, the cost of repair and replacement of the part or product, as indicated beforehand by the client, will be paid by the client.

1. FIAMMA garantit ses propres articles pour une période de 12 mois à partir de la date d'achat effectué par le consommateur final.
2. Fiamma accepte la garantie pour des dommages dus à un défaut du matériel ou à une non-conformité de production.
3. Aucune garantie n'est acceptée pour les pièces sujettes à usure naturelle, au cas où le mode d'emploi et les instructions d'installation n'auraient pas été suivis, en cas de négligence ou d'usage non conforme, en cas d'utilisation de pièces détachées autres que celles de marque Fiamma, en cas d'emballage ou de transport non conformes ou non autorisés par Fiamma, en cas d'intervention d'une personne non qualifiée, si l'utilisateur final ou que quelqu'un d'autre a apporté des modifications à l'article sans l'autorisation de Fiamma.
4. Pour les cas où les conditions pour le recours à la garantie seront applicables, Fiamma répondra du dommage en décidant soit d'effectuer une réparation soit de remplacer la pièce défectueuse.
5. Pour effectuer une réclamation, veuillez vous adresser auprès du revendeur où vous avez effectué votre achat. Vous devrez toujours indiquer le numéro de série du produit, la référence de la facture ou du ticket de caisse (Fiamma pourra vous en demander la copie) et une description précise du dommage (des photos numériques seraient la meilleure solution). En cas d'information fausses et/ou incomplètes, Fiamma ne pourra pas appliquer les conditions de droits à la garantie.
6. Fiamma peut demander le retour du produit pour vérifier l'applicabilité des droits de garantie. Les frais et les risques d'expédition sont à la charge du client. Si le recours en garantie est applicable, Fiamma payera les frais de transport, c'est-à-dire les coûts d'envoi et de restitution de l'article en plus des frais liés à la réparation du dommage. En cas de non applicabilité du recours en garantie, les coûts de réparation et de restitution de l'article, desquels le client aura été informé au préalable, seront à la charge du client.

1. FIAMMA garantiza los propios productos por un periodo de 12 meses a partir de la fecha de adquisición
2. FIAMMA reconoce la garantía por averías debidas a defectos de la lona o que no son en conformidad de producción.
3. No se reconoce garantía en caso de partes dañadas por desgaste y en caso de consunción natural debida al uso, en caso de negligencia o de utilización inadecuada, en caso de uso de recambios no originales Fiamma, a consecuencia de un embalaje por el transporte inadecuado o no autorizado por Fiamma, en caso de intervención de una persona no cualificada, en el caso de que los que efectivamente utilizan los productos aporten modificaciones sin la autorización Fiamma.
4. En el caso de que el producto resulte en garantía, Fiamma se preocupará de eliminar la avería, decidiendo si repararlo o sustituir la parte defectuosa.
5. Para la exhibición del reclamo, dirigirse al revendedor donde se ha comprado el producto. Se debe siempre indicar el número de serie del producto, la referencia de la factura o del ticket de caja (FIAMMA podrá pedir una copia) y una descripción precisa de la avería (lo mejor son las fotos digitales). En caso de informaciones falsas o incompletas FIAMMA no aplicará los derechos de garantía.
6. FIAMMA puede pedir el regreso del producto para verificar la existencia de los derechos de garantía. Los gastos y los riesgos de la expedición son a cargo del cliente. Si la petición de aplicación de la garantía vendrá valutada válida, FIAMMA sostendrá los gastos de transporte, es decir los gastos de envío y de devolución, además de los gastos para la eliminación de la avería. En caso de no aplicabilidad de los derechos de garantía, los gastos de reparación y de devolución del producto, serán a cargo del cliente.



**CARRY-BIKE Airstream**

02093-97-

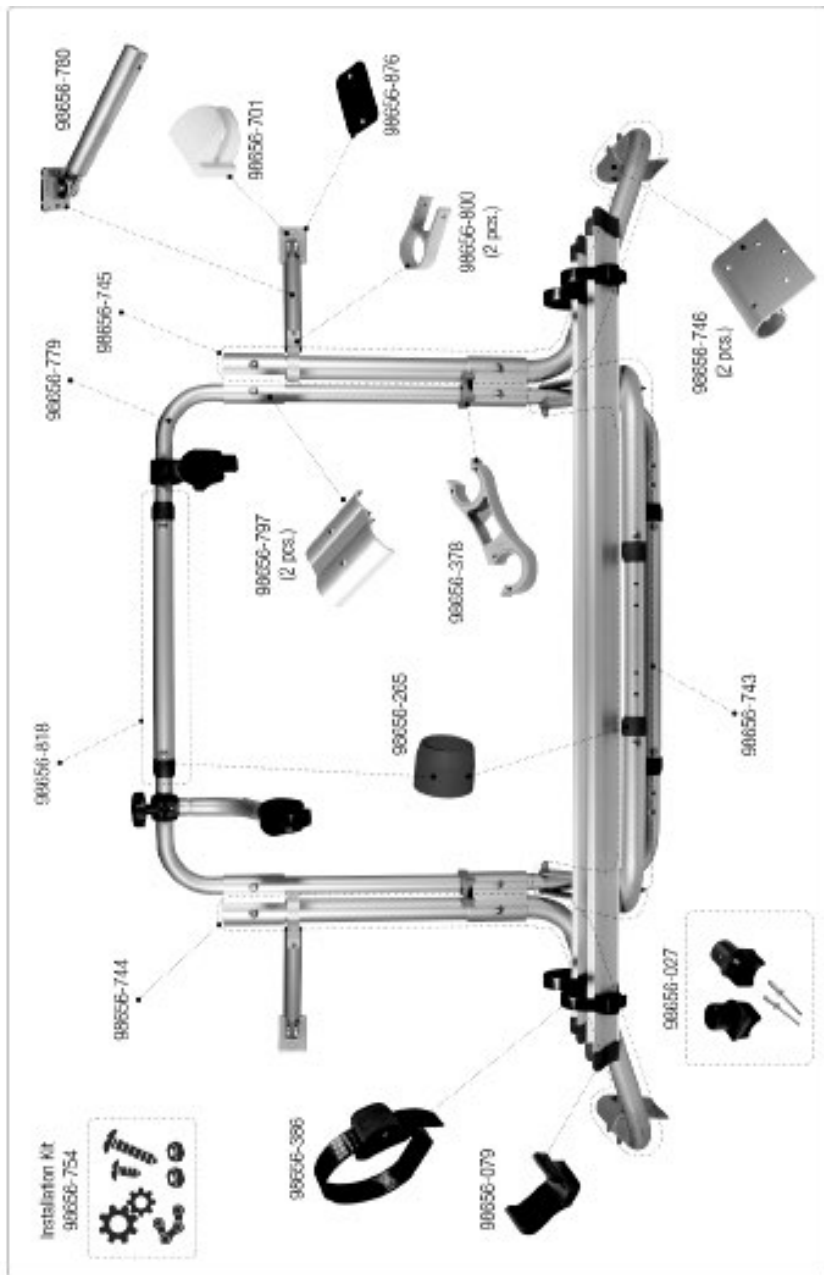

**EN** Ersatzteile  
**FR** Pièces détachées  
**ES** Recambios

**EN** In case of problems, please quote this Serial Number.  
**FR** En cas de problème, merci de communiquer ce numéro de référence.  
**ES** En caso de problemas, comunicar los datos sobre la etiqueta.



**EN** Safeguarding the environment  
**FR** Protection de l'environnement  
**ES** Protección del ambiente

**EN** DISPOSAL OF PACKAGING MATERIALS  
The packaging material is 100% recyclable. Packing materials should therefore not be thrown away with household rubbish, but disposed of according to local laws.

**FR** ÉLIMINATION DES EMBALLAGES  
Les matériaux d'emballage sont entièrement recyclables. Par conséquent, ne les jetez jamais dans la nature mais conformez-vous aux réglementations locales en vigueur en matière d'élimination des déchets.

**ES** ELIMINACION DEL EMBALAJE  
El material del embalaje es reciclable al 100%. Las diferentes partes del embalaje no tienen que dispersarse en el ambiente, sino que deben ser eliminadas en conformidad con las normas establecidas por las autoridades locales.





fiamma.com

All rights reserved.

Fiamma S.p.A. reserves the right to modify at any time, without notice, prices, materials, specifications and models or to cease production of any model.

**02093-97-**



MO\_IS\_98690M005\_revH (^INC)

Carry-Bike

**Fiamma SpA - Italy**  
Via San Rocco, 56  
21010 Cardano al Campo (VA)