

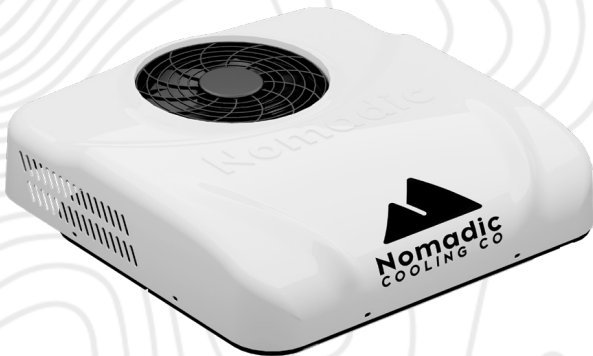

NC-X³ Install Manual

48V | 24V | 12V

Version 240325



16680 N 51st Ave Units 4 & 5
Glendale, AZ 85306
(480) 576-2489

www.NomadicCooling.com/Support

TABLE OF CONTENTS

INTRODUCTION	2
RETURNS.....	2
ITEMIZED PARTS LIST	3
NC-X ³ EXPLODED COMPONENT VIEW ...	4
IMPORTANT SAFETY INSTRUCTIONS.....	5
NC-X ³ SPECIFICATIONS	6
INSTALLATION STEPS	7
ELECTRICAL WIRING DIAGRAM 48V.....	12
ELECTRICAL WIRING DIAGRAM 12/24V...	14
WARRANTY POLICY.....	16
RETURNS, CANCELLATIONS, and MISSING PARTS.....	17

INTRODUCTION

The NC-X³ Air Conditioner ("AC unit") is designed and intended for installation on the roof of a recreational vehicle during or after the vehicle is manufactured.

The NC-X³ can be installed by one person with brief help from one additional person. Reading this installation manual in its entirety first will ensure the proper installation and function of the NC-X³.

 **Nomadic**
COOLING CO
16680 N 51st Ave Units 4 & 5
Glendale, AZ 85306
(480) 576-2489
www.NomadicCooling.com/Support

Keep a record of the following information:

Model **NC-X³ Rooftop AC Unit** | 48V
24V
12V

Serial No. _____

Date Purchased _____

Installed By _____

RETURNS

Nomadic Cooling will gladly accept returns within 30 days of receiving the order. Only items in their original condition with all packaging, accessories, instruction manuals, warranty cards, and UPC codes will be accepted. Any returns after 30 days are subject to approval.

Nomadic Cooling reserves the right to modify appearance and specifications without notice.



Always bench test AC unit before installing.



Check to ensure all required parts are included (see page 3).

Get social with us!



@nomadiccooling



ITEMIZED PARTS LIST

PARTS LIST

NC-X³ AC Unit (Host Box)

ID	Qty	Part Name	
A	1	NC-X ³ AC Unit (Arctic White or Obsidian Black shroud)	<input type="checkbox"/>
B	1	Foam gasket	<input type="checkbox"/>
C	2	Crossbars	<input type="checkbox"/>
D	1	Faceplate (flush mount)	<input type="checkbox"/>
E	9	Faceplate screws (black)	<input type="checkbox"/>
F	4	Lock washers for mounting bolts	<input type="checkbox"/>
G	4	Washers for mounting bolts	<input type="checkbox"/>
H	4	Mounting bolts (M8)	<input type="checkbox"/>
I	4	Mounting nuts	<input type="checkbox"/>
J	1	Remote control	<input type="checkbox"/>
K	1	Foam Leveling Strip (I) and Air Separator (I)	<input type="checkbox"/>
L	1	Bagged and boxed Control Panel and Wiring Harness	<input type="checkbox"/>
M	1	Note: 48V (only) harness has an inline fuse.	<input type="checkbox"/>
N	1	48V only: Rooftop template with 14" x 14" cutout	<input type="checkbox"/>
O	1	24V/12V only: Fuse holder and fuse (24V = 60A, 12V = 125A)	<input type="checkbox"/>

NC-X³ DIY Kit (Optional)

O	1	48V only: Fuse holder and 30A fuse	<input type="checkbox"/>
P	1	Power Bundle, Anderson/Anderson-style connector	<input type="checkbox"/>
Q	1	NC-X ³ Trim ring	<input type="checkbox"/>
R	1	14" x 14" Cardboard template for rooftop cutout	<input type="checkbox"/>
S	20	Zip ties (10 large + 10 small) and Sticky Plates (10)	<input type="checkbox"/>
T	1	Tube of polyurethane adhesive sealant	<input type="checkbox"/>
U	1	Wide thermo tape (5 ft) for foam air separator	<input type="checkbox"/>
V	1	5/16" terminals (4), 3/4" heat shrink wraps (3 red, 1 black), and thread-locker (1)	<input type="checkbox"/>
W	10	Washers (are not used)	<input type="checkbox"/>

Representative products pictured are subject to change without notice.



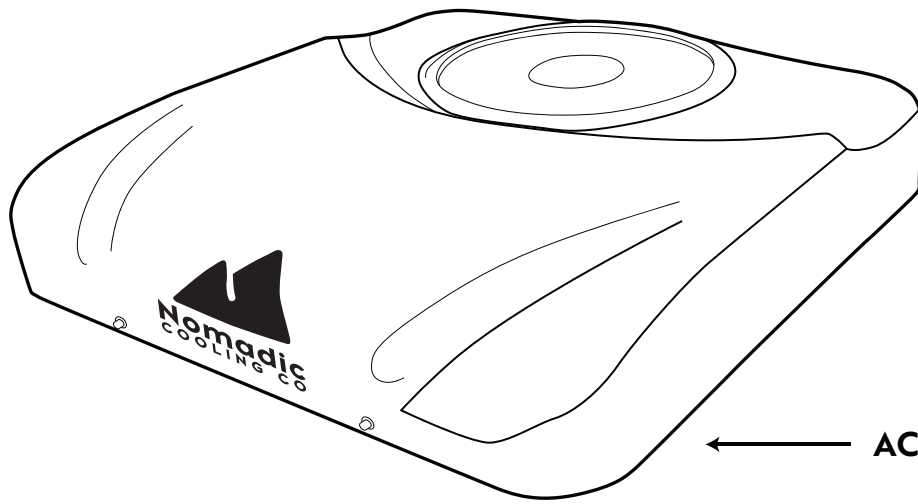

← AC Unit and Shroud

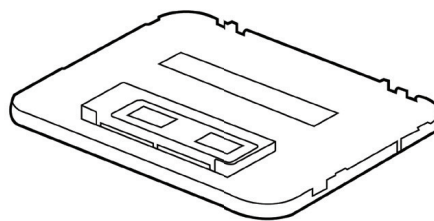

← AC Base Plate

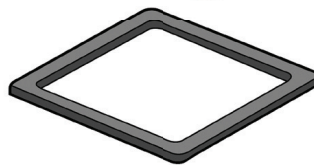

← Foam Gasket

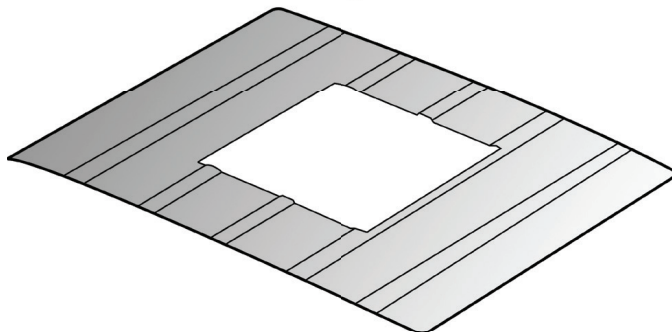

← Vehicle Roof

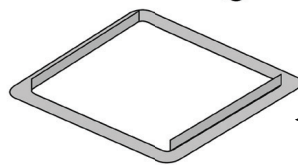

← Optional X3
Trim Ring (DIY Kit)

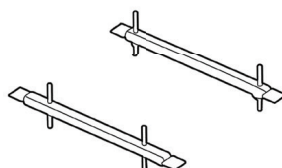

← Crossbars



16680 N 51st Ave Units 4 & 5
Glendale, AZ 85306
(480) 576-2489

www.NomadicCooling.com/Support

IMPORTANT SAFETY INSTRUCTIONS

This manual contains safety guidelines and instructions that can aid in reducing or eliminating the risk of accidents and injuries.

A. Recognizing Safety Information

The safety alert symbol is utilized to notify potential physical injury hazards. To avoid possible injury or death, follow all safety messages that come after this symbol.

B. Understanding Signal Words

Signal words identify safety and property damage messages and indicate the degree of hazard seriousness.



WARNING is used for hazardous situations that could result injury (including death, severe, moderate or minor injury if not avoided).



NOTICE is used for situations that could result in AC unit or vehicle damage or unnecessary complications in the installation process.



HELPFUL TIP is used for useful information or best practices.

C. Supplemental Directives

To avoid potential injury and even death, read and follow all of the safety information and instructions.

Read and comprehend these instructions before installing, using, servicing, or maintaining this AC unit. Poor installation, operation, servicing, or maintenance of this AC unit can result in severe injury. Follow all instructions.

The installation must comply with all applicable local and national codes, including the latest edition of the following standards:

USA

- ANSI/NFPA70, National Electrical Code (NEC)
- ANSI/NFPA1192, Recreational Vehicle Code

CANADA

- CSA C22.1. Parts I & II, Canadian Electrical Code
- CSA Z240 RV Series, Recreational Vehicles

D. General Safety Messages

WARNING - Failure to follow the subsequent warnings could lead to death or serious injury.

- A qualified service technician **MUST** install or service this product.
- Do **NOT** modify this product in any way. Modifications can be extremely dangerous and void any warranties.
- Do **NOT** add any devices or accessories to the AC unit unless specifically authorized in writing by Nomadic Cooling Co.

NC-X³ SPECIFICATIONS



OFF-GRID AIR CONDITIONING SYSTEMS FOR VANS, RVS & RIGS



PRODUCT:
MODEL:

NC-X³ Rooftop AC Unit
48V/24V/12V AW/OBS

Shroud available in Arctic White or Obsidian Black.

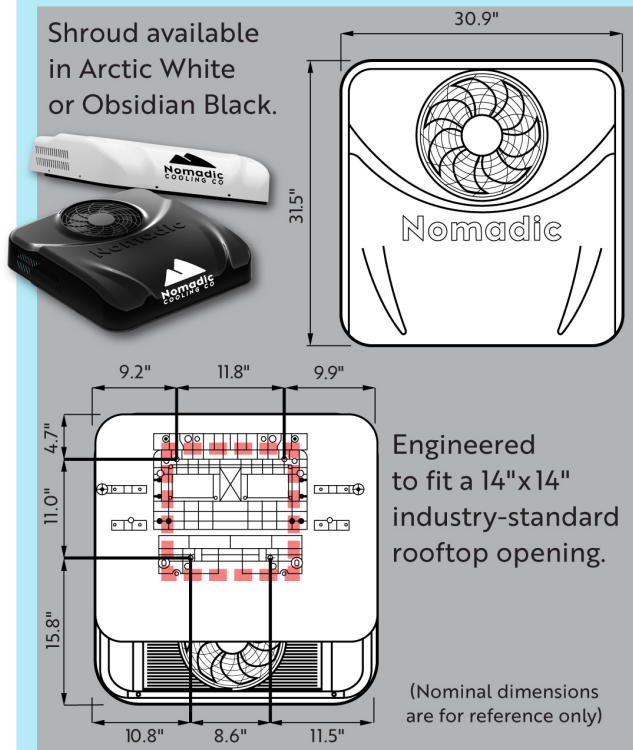

MODEL	48V	24V	12V
Current ECO Mode	14A	30A	50A
Current MAX Mode	27A	55A	110A
Rated Power	1,680W	1,390W	1,320W
Fuse Size	30A	60A	125A
Power Cord Specification	8AWG	2AWG	2AWG
Rated Cooling Capacity (BTU)	15,120	12,480	11,830
Refrigerant	R134a @ 600g ± 30g		
Refrigerant Oil	POE68		
Speed Range	1,000 to 3,000 RPM		
Weight	57.3 lbs		
Interior Faceplate Dimensions	16¼" x 16¼" (Flush Mount)		
Compressor Motor	18cc PWM, Spring Bushings		
Evaporator Motor	Brushless with 10" Fan		
Condenser Fan	14"		
Noise (Decibals)	≤60 dBa		
Operation Modes	Auto/ECO/MAX/Fan		
Min-Max Temperature Setting	60°F to 86°F		
Warranty	One (1) Year w/ Extension Opt.		

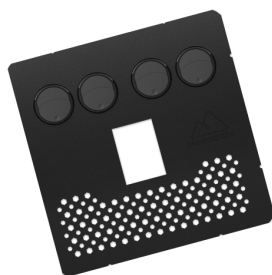

Flush-mounted, powder-coated, obsidian black interior faceplate



Remote control included



Modern, crisp LCD control panel

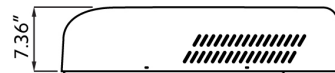

48V, 24V and 12V options are available



User Installation Guide and Operations Manual available at NomadicCooling.com

GO FURTHER IN COMFORT

INSTALLATION STEPS

1. Mark your 14"x14" rooftop opening. DIY Kit includes a cardboard template. Cut from the exterior of your vehicle.



Never cover AC unit top fan.



When determining AC unit location, be sure to allow for the shroud (cover) when positioned on the roof.



Make sure there is no electrical or other encumbrances in the way.



Do not cut into structural beams.

2. Make sure the planned opening is centered from all four sides. This gives the best chance for easy installation.

Vehicle Front

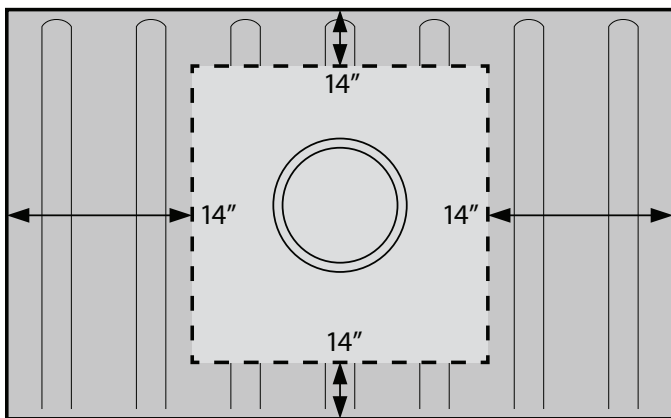

Exterior Roof

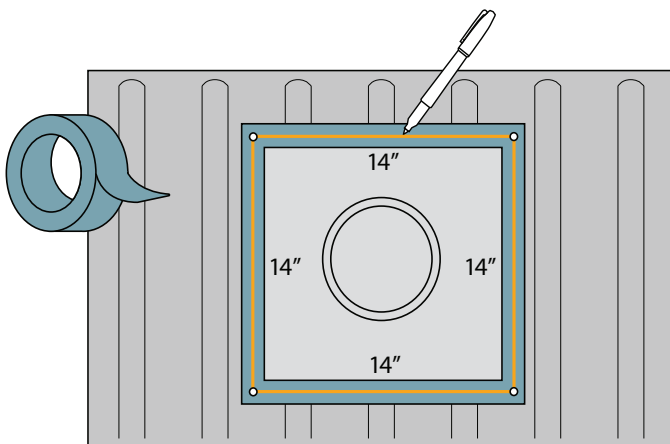

Exterior Roof



Use painter's tape and a permanent marker to draw your 14"x14" cutline.



Make multiple passes with the marker.



If you make a mistake replace the tape and try again. Measure repeatedly to make sure your lines create a perfect 14"x14" square.

3. Drill each corner of your markings through the roof. This will make it easier to detect the location of your 14"x14" opening from the underside of your roof.

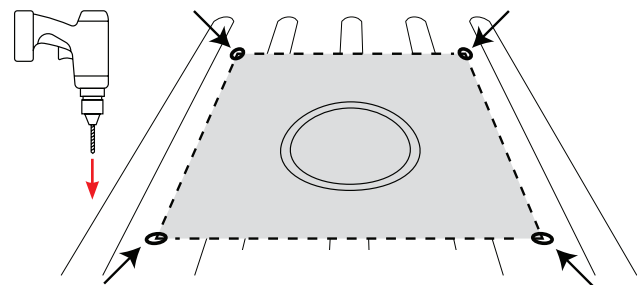

Exterior Roof

Use a 1/8" drill bit for corner holes.



4. Cut on your lines using a jig saw, nibbler or cutting wheel.

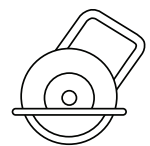
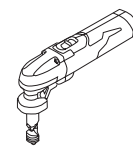
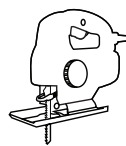

Use a sander or file to smooth out the rough edges after cutting.

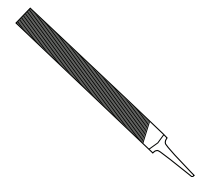
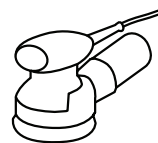

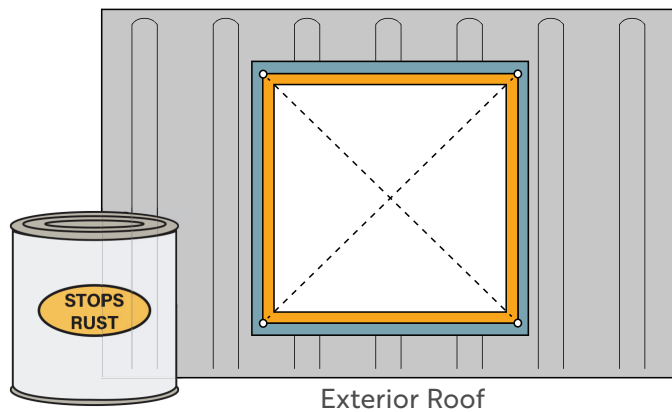

5. **Paint** around the edges of the cut roof opening to prevent rust. You can use any color rust-preventative paint.

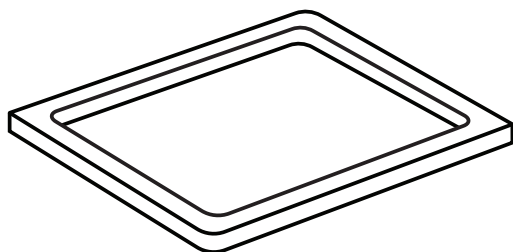

6. **Remove tape** and clean exterior surface.

7. **Remove 14"x14" waterproof gasket** from box.





 Make sure area/paint is clean, dry and clear of all debris.

 Use alcohol wipes or PrepSol to remove oil or wax from vehicle roof.

If placing gasket over a high or uneven roof surface, remove small amounts of the 14"x14" gasket to match roof contours.

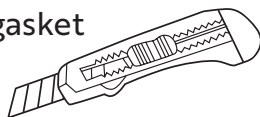
 Use blade to cut away gasket if needed.



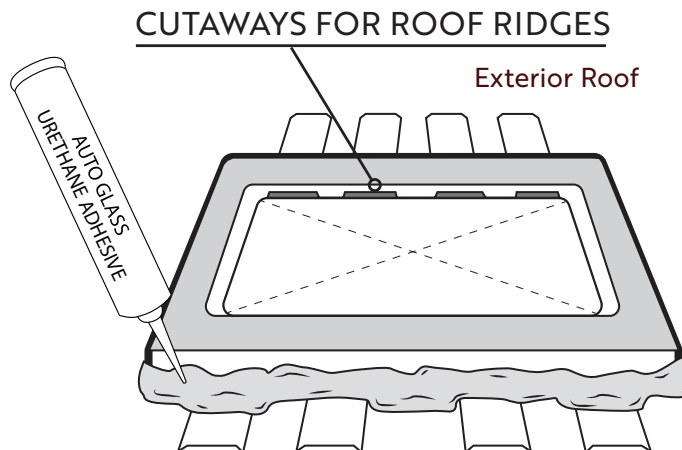

 Remove gasket adhesive only after making any necessary cuts. Place the gasket sticky side down.

8. **Apply window weld/adhesive** around 14"x14" gasket, after sticking it down on vehicle roof. DIY kit includes a tube of polyurethane adhesive sealant.



9. **Place AC unit on roof** over 14"x14" gasket gently. Measure side-to-side until unit is centered on all four sides.

 Be careful not to puncture, rip or tear the gasket with the AC unit's mounting bolts.

 Do not put adhesive on top of gasket.

 Do not damage electrical components when placing AC unit.

10. **Adhere optional leveling strip** behind the 14"x14" gasket. If you do, remove the two rubber feet at the back of the AC unit.

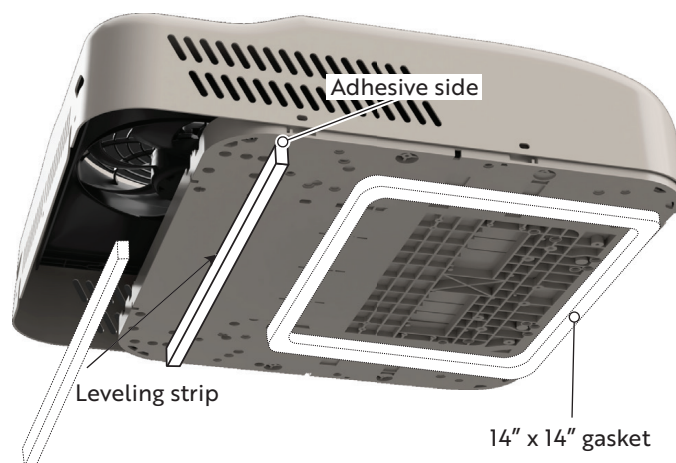

11. From inside the vehicle add the crossbars with mounting bolts to securely attach AC unit to the roof.

A trim ring (included with DIY kit) should be placed between the vehicle roof and the AC unit before crossbars are added.

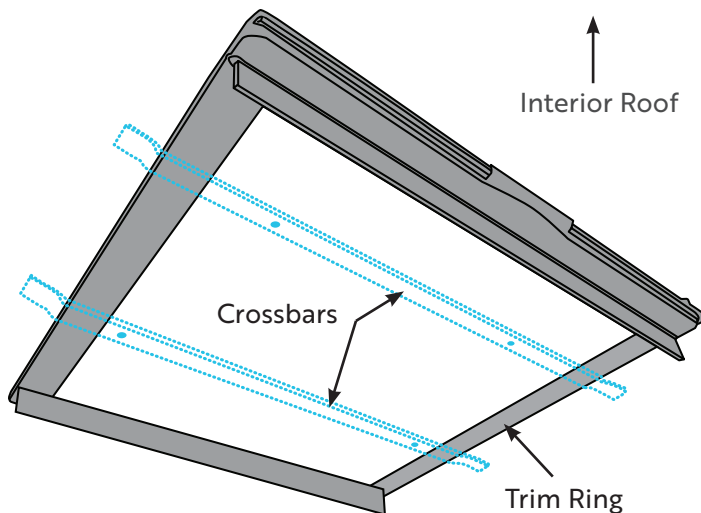



 Do not use electric drill on crossbars.

Put the washer/lock washer on each M8 bolt and hand tighten (+1/4 turn) bolt into the AC base plate until the crossbars are secure.

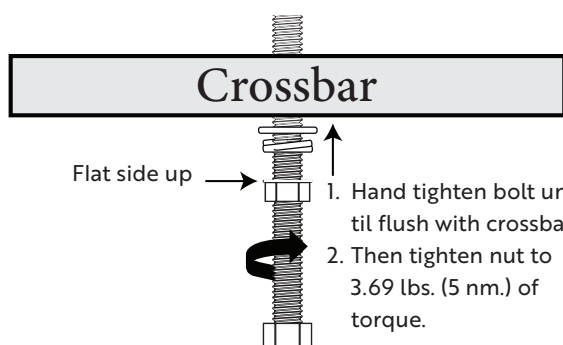
Tighten all four of the nuts to the crossbar to 3.7 lbs. of torque (~5 nm).



 AC unit will help to create pressure. When securing AC unit to the vehicle, increased compression of the gasket will level the unit against the roof. No light should be visible.

 Do not over-tighten mounting bolts. Bolts will rotate if over torqued, and may break from AC base plate.

 Over-tightening will void warranty.

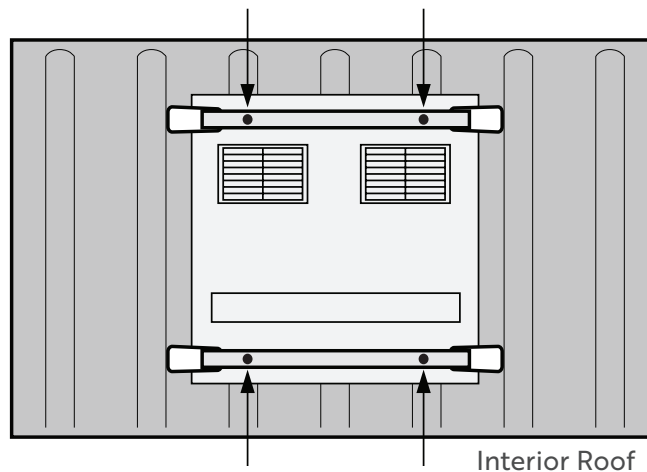

 Our gaskets are used for vibration absorption. It is very high density and can't be compressed more than 10%. Use gasket tension to control AC unit's distance from roof surface.

AC unit should be resting on foam gasket and *not* on the vehicle's roof.

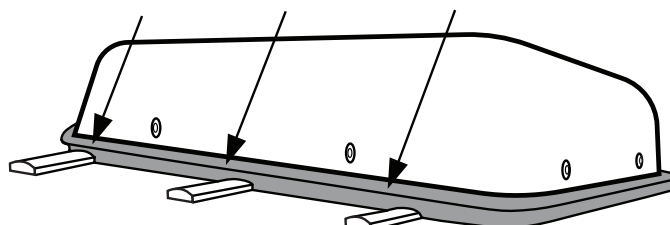

 Over-compression of the AC unit to the roof may cause the internal fan to rub against the fan housing.

 Be sure the fan blades rotate freely prior to starting the AC unit.

12. Install and connect LCD control panel before connecting to power to avoid blowing internal fuse.



An appropriately-sized fuse must be placed between your power source and the AC unit:

48V = 30A fuse
 24V = 60A fuse
 12V = 125A fuse



An appropriate fuse and fuse holder is included in the Host or DIY box.

13. Connect DC power wires to unit. "Quick Connection to DC Wiring Harness" included

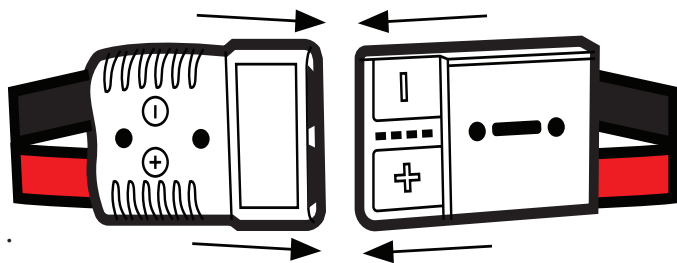

Make sure wiring is appropriately sized and is no smaller than:

2AWG for 12V/24V AC units, or
 8AWG for 48V AC units.

14. Attach LCD control panel and AC wiring harnesses.

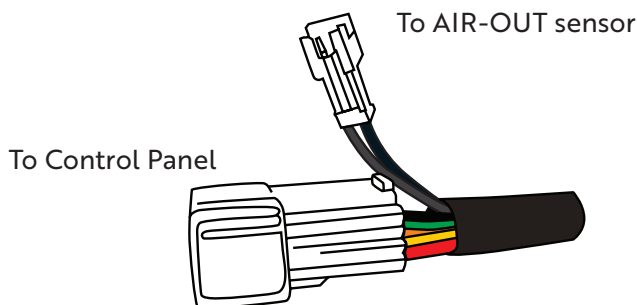

15. Attach thermostat wires to control panel wiring harness.

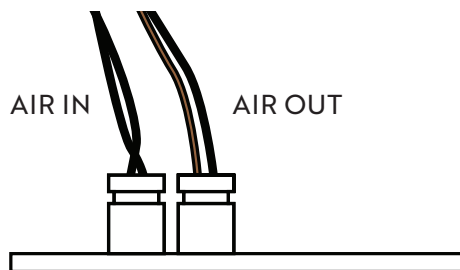

For details of control panel connections, refer to electrical wiring diagram on page 12.



Condenser is always to the left of the black wire. Be careful not to break these wires.

16. Use the foam separator to properly separate hot air from cold air as it enters and exits the AC unit.

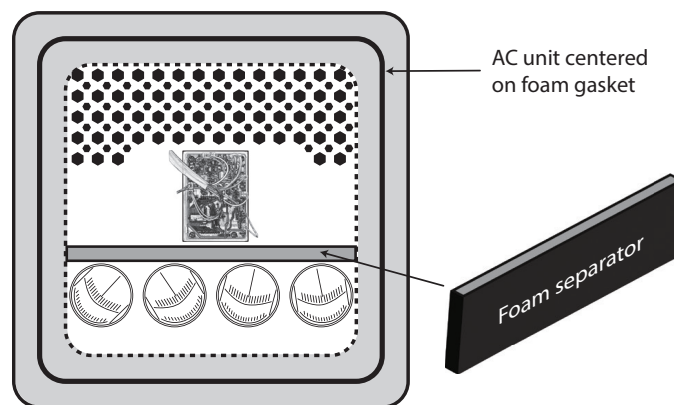

17. Use heat resistant tape to secure the air separator in place. Use your best judgment on how much tape to use and where to adhere it, as every installation is different. The tape helps the air separator keep the warm and cool air separated.

18. Test all connections between the power source and the unit for excessive heat during normal operations.

19. Install faceplate. Line up the faceplate vents with the air-out fan openings in the AC base plate. Use the 8 screws to secure the faceplate to the ceiling of your vehicle. The DIY kit screws do not require pre-drilling into the ceiling, regardless of finish or material (wood or metal).



The faceplate does not screw into the base of the AC unit. It attaches (flush) to the vehicle's ceiling directly.

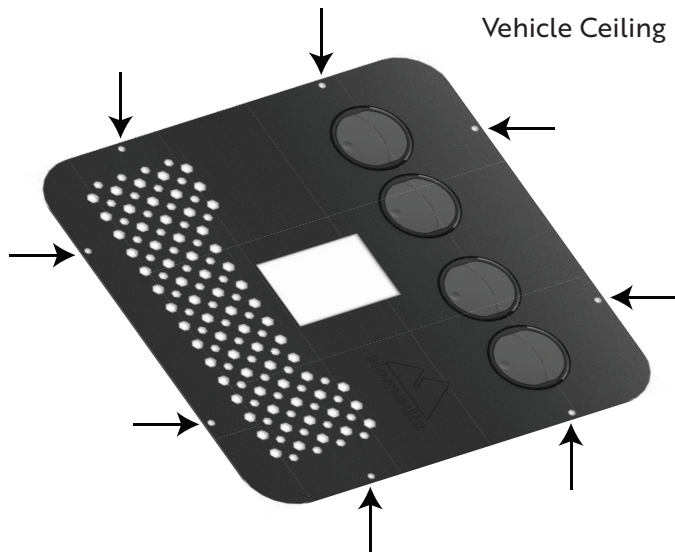

Congratulations!

Your Nomadic Cooling X³ AC unit rooftop installation is complete. Now...

**GO FURTHER
IN COMFORT** 

Exploded NC-X³ Components

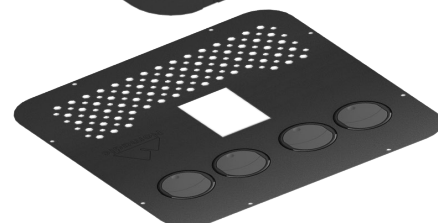
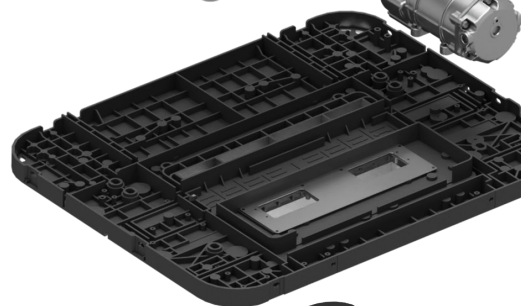
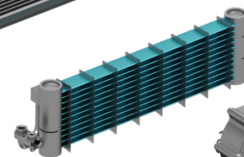
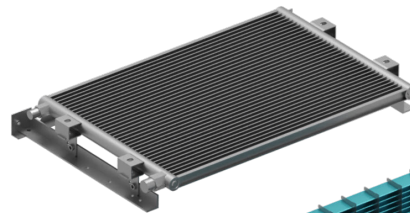
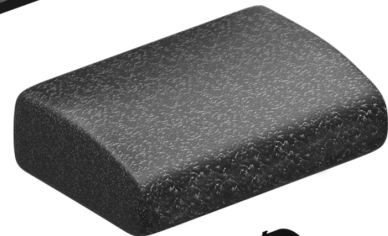
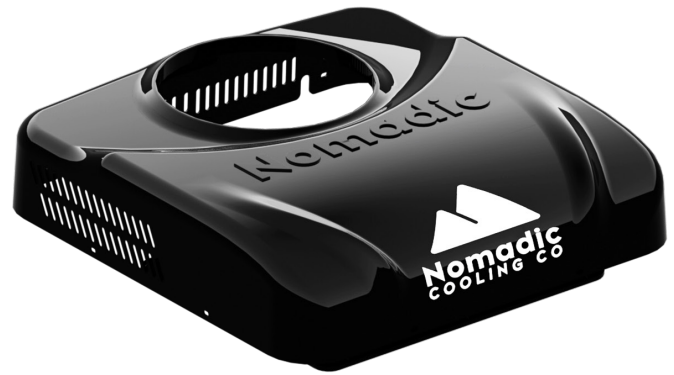

Electrical Wiring Diagram



48V

Legend	Wire Diameter
—	20 AWG 0.5mm
-----	18 AWG 1.0mm
—	10 AWG 2.5mm
—	8 AWG 6.5mm

- Control Panel Connections**
- 2.5 Red - Power supply (48V) POS +
 - 2.5 Black - Power supply (48V) NEG -
 - 2.5 Blue - Condensor Fan POS +
 - 2.5 Yellow - Condensor Fan NEG -
 - 0.5 Red - Voltage monitoring
 - 1.0 Blue - Fan speed regulator NEG -
 - 1.0 White - Fan signal POS +
 - 1.0 Green - Compressor variable signal
 - 1.0 Brown - Compressor start signal

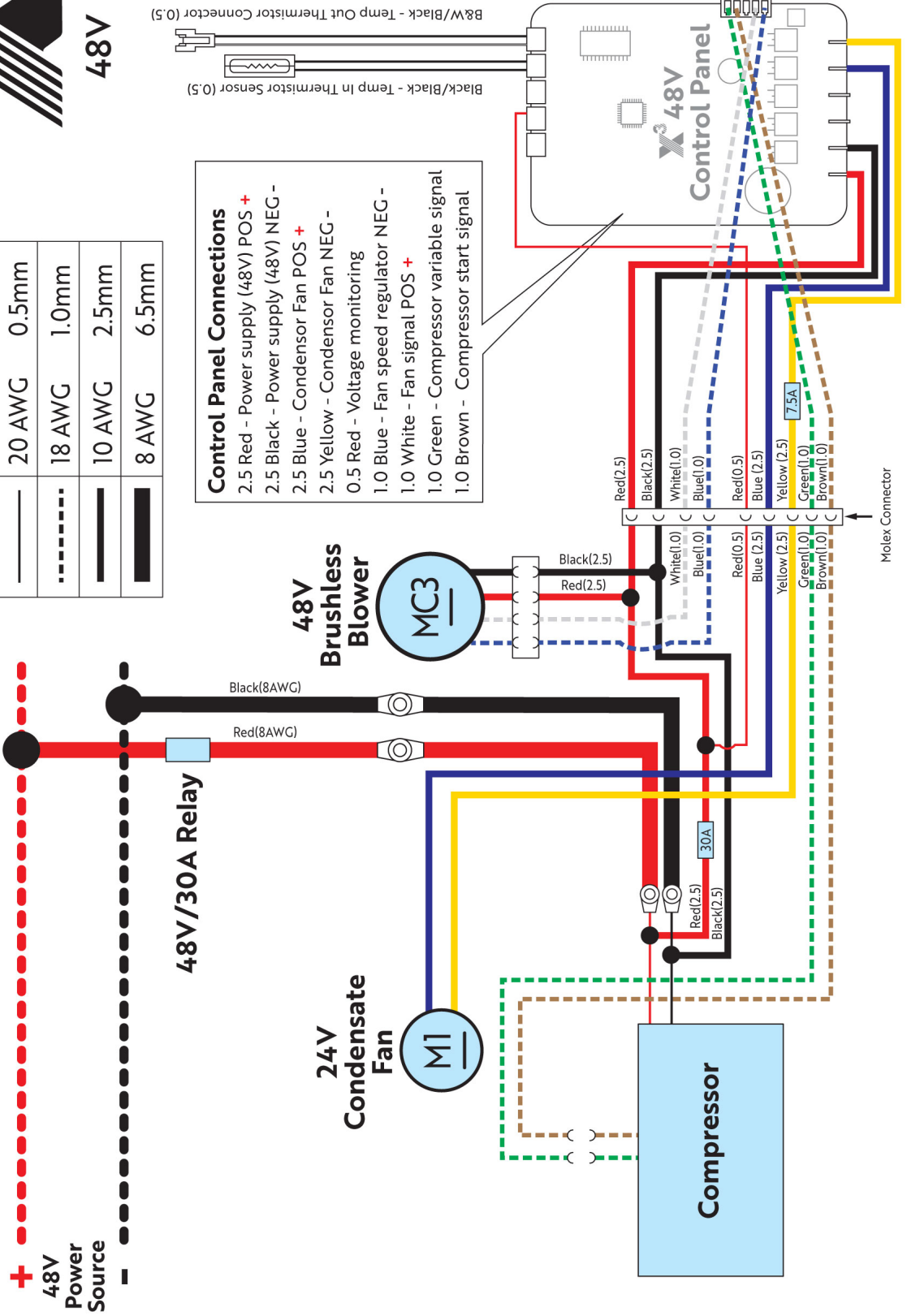

Control Panel Wiring

Shown below is a properly wired LED Control Panel for the X³ 48V model.



48V

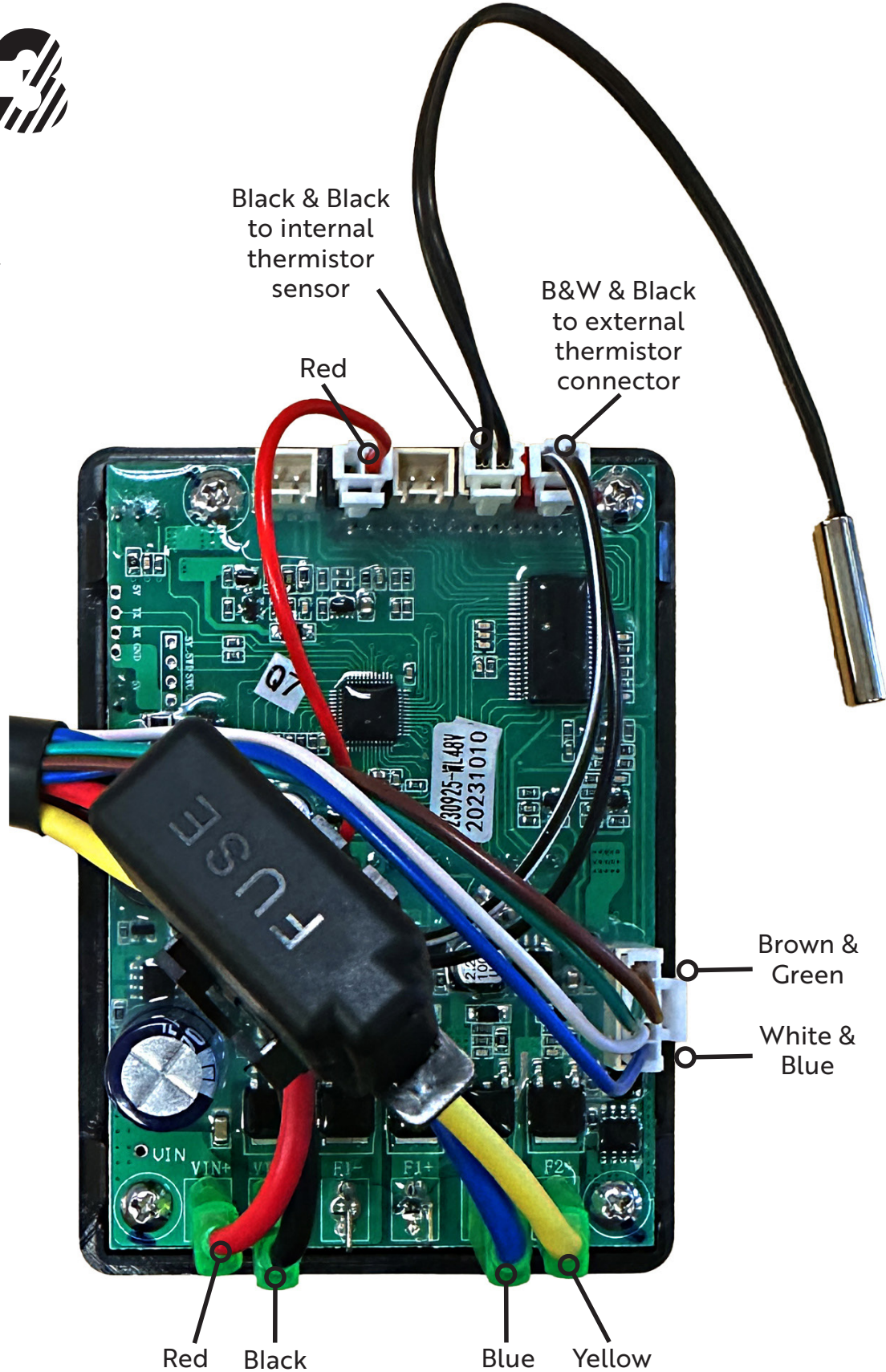

Control Panel Wiring

Shown below is a properly wired LED Control Panel for the X³ 12V and 24V models.



24V | 12V

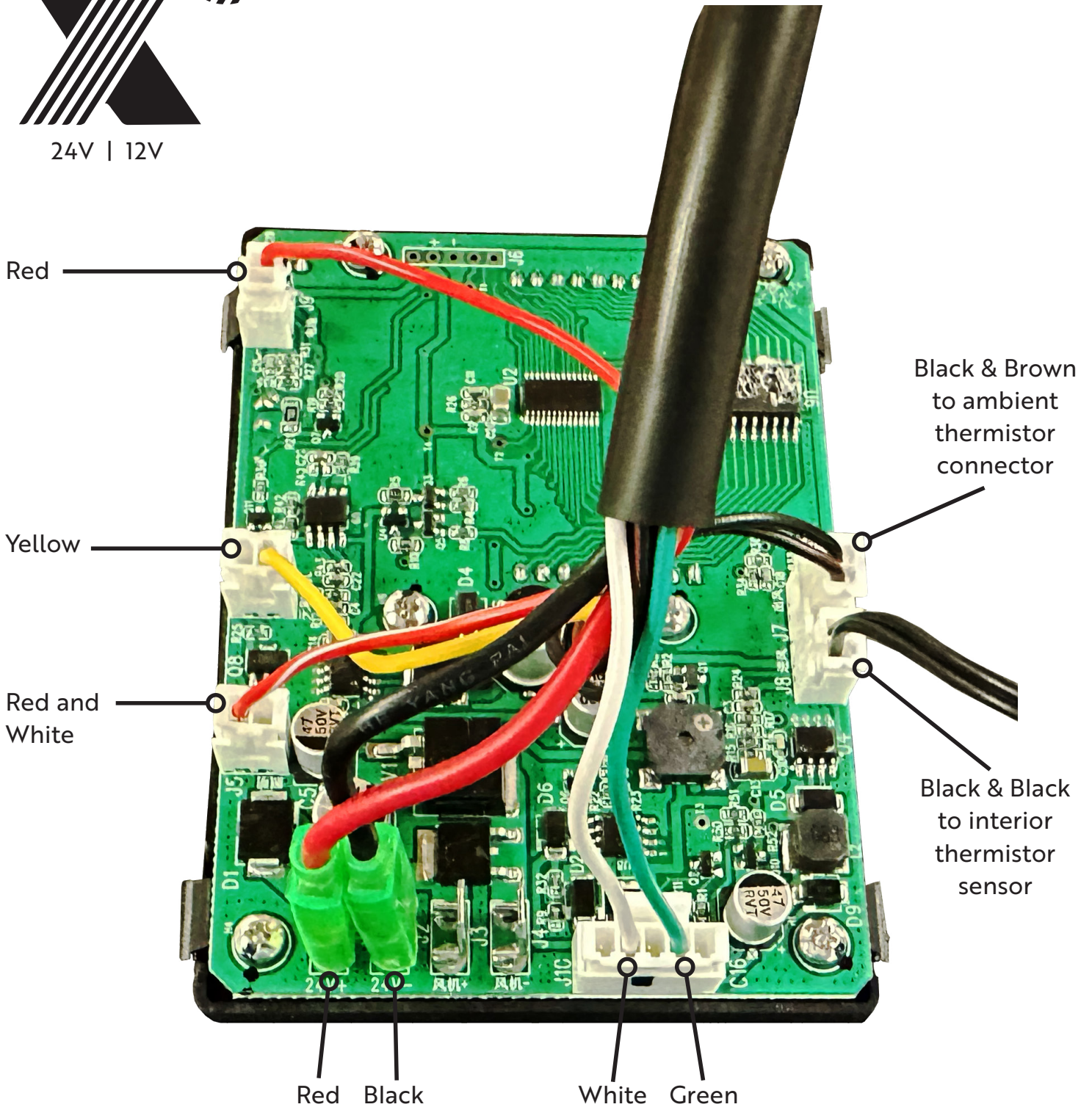



WARRANTY POLICY For X Series DC-Powered Rooftop AC Units

Nomadic Cooling is dedicated to delivering top-quality products coupled with outstanding customer service. We provide an industry-leading warranty for our products to ensure your satisfaction and peace of mind. Technical support is available for the lifetime of any X Series AC unit. Please review the following warranty policy.

1. Warranty Period

All X Series AC units are covered by a one year warranty period which begins on date of purchase. An optional one-year extended warranty is available if purchased prior to initial warranty period expiration. Note: X³ AC units purchased prior to December 1, 2023 are covered by an initial two-year warranty.

2. Warranty Coverage

During the warranty period, the Nomadic Cooling Co Warranty will cover all X Series AC units that experience any defects due to manufacturing or workmanship issues. The customer shall be responsible for all shipping costs to get the X Series AC unit to and from Nomadic Cooling for inspection, repair, replacement or upgrade.

3. Optional Extended Warranty (X2 and X3)

You may purchase a one-year extended warranty for any X Series AC unit which provides the same coverage as described above (#2).

4. Optional Refundable Core Charge

If you wish to have a replacement X Series AC unit shipped prior to Nomadic Cooling receiving the warranted unit, a core charge of up to 50% of the Manufacturer's Suggested Retail Price (MSRP) may apply. This core charge is intended to ensure the return of the warranted unit to Nomadic Cooling. The core charge will be added to the purchase price of the replacement unit and is refunded upon Nomadic Cooling's receipt and evaluation of the returned unit. If the warranty department determines that a defect was due to Nomadic Cooling's fault, the core charge will be refunded in full.

5. Exclusions and Limitations

The following are not covered by the warranty:

- Damage caused by misuse, negligence, accidents, or unauthorized modifications.
- Damage resulting from improper installation, maintenance, or storage.
- Damage caused by natural disasters, fire, water, or any other external factors beyond our control.
- Normal wear and tear, cosmetic damages, or minor imperfections that do not affect the functionality of the product.
- Warranty, including an optional extended warranty, is non-transferable.

6. Labor Exclusion

Nomadic Cooling's warranty policy does not cover any labor costs associated with the inspection, repair, or replacement of an X Series AC unit. Any additional expenses related to labor, including but not limited to installation, removal, or troubleshooting, shall be the sole responsibility of the customer.

7. Warranty Claims

To initiate a warranty claim, please e-mail or call us. Our representatives will guide you through the necessary steps and provide instructions on how to proceed with the warranty claim.

Please note that this warranty policy is subject to the terms and conditions stated herein and may be subject to change without prior notice. Nomadic Cooling reserves the right to determine the validity of all warranty claims and to make the final decision regarding repairs, replacements, or refunds.

**For warranty claims, additional information
or any questions, please contact us at:**

**Support@NomadicCooling.com
or call us at (480) 576-2489.**

231130

RETURNS, CANCELLATIONS AND MISSING ITEMS

Returns

Nomadic Cooling will gladly accept returns within 30 days of acceptance of order. Please e-mail Info@NomadicCooling.com or call (480) 576-2489. Any returns after 30 days are subject to prior approval.

Only items in their original condition with all packaging, accessories, instruction manuals, warranty cards, and UPC codes will be accepted for return.

A 15% restocking fee will be assessed for all return orders. Customers are responsible for the cost of shipping of any product returned to Nomadic Cooling. We are happy to arrange for return shipping using our provider rates, or shipping can be arranged independently. Returns must include a tracking number.

If a returned product arrives at Nomadic Cooling with damage due to mishandling, poor packaging, or in otherwise unusable condition for resale, then an additional fee may be assessed.

Products should be returned to:

Nomadic Cooling Co
16680 N 51st Ave Unit 4-5
Glendale, AZ 85306

Due to some products being shipped directly from the manufacturer, please check with a Nomadic Cooling employee where to send all other returns.

Returned products will be assessed for damage upon receiving at Nomadic Cooling.

Refunds will not be processed until the product is received, inspected, and/or tested by Nomadic Cooling.

All refunds will be processed back to the original payment method and/or store credit.

Order Cancellations

If you wish to cancel your order for any reason, please let us know as soon as possible. Please e-mail Info@NomadicCooling.com or call (480) 576-2489.

If you are canceling before the order has been shipped, then we will process a refund back to the original payment method. If you are canceling after the order has been fulfilled, then the cancellation will be processed as a return and is subject the restocking fee and shipping costs. If applicable, you will be responsible for any "stop and return" fees.

Missing Items

Upon receiving your order from Nomadic Cooling, please immediately open the package and inspect the contents to ensure all items from the order have been included. If you suspect that an item is missing or the incorrect item was sent, please notify a Nomadic Cooling employee ASAP so we can assess the order. If you fail to notify Nomadic Cooling within 14 days of accepting an order with missing or incorrect items, then you will be responsible for shipping costs for the missing or incorrect item(s).

To better prevent orders with missing or duplicate items, and for ease of tracking, Nomadic Cooling will only be shipping orders once all items in the order are ready for shipping. Nomadic Cooling will not send partial shipments. Exceptions may occur when specifically requested by the customer and/or item(s) in the order are on backorder. Products are shipped the same day they are packaged and ready, unless requested otherwise.

X Series Troubleshooting

All of our AC units are bench tested before leaving the Nomadic Cooling warehouse. In the unfortunate event that your AC unit is not working properly, you should consider some of these more common problems that our technical support team encounter.

1. Power issues. Using a voltmeter, measure the voltage the AC unit is receiving from the power source. A drop in expected power will cause a drop in cooling capacity for the AC unit, just as it would cause a light bulb to not glow as brightly.

A. If the voltage getting to the AC unit is low, the first thing to consider is the distance from the power source to the AC unit. Voltage loss in wires increases as the distance grows. Our AC unit power cord specifications are conservative, but if the distance is greater than 15-20 feet, it may be necessary to use a thicker gauge wire.

If wiring distance is not an issue, then check the following:

B. Check the fuse or breaker, or any other inline components between your power source and the AC unit. Check the wiring connections to and from these components. Ensure that your fuse or breaker are properly set, inspect the wiring in and around such components for any cracks or looseness.

C. Check the wires from your power source to your AC unit. While running these wires through a vehicle's framework, it can be necessary to twist and wrap around obstacles, or feed them through narrow spaces, often with sharp edges exposed. This can result in damage to

the wires or insulation, which will cause a grounding or short, and a drop in amperage to the AC unit.

2. Are the Crossbar Bolts are too long for your build? Every build is different, and if you find that the crossbar bolts are too long, you can use a cold saw, bandsaw, grinder or hacksaw to trim them down to the length you need.



Remember to wear safety goggles!



Thread the nut before cutting the bolt and then use it to re-form the thread after cutting.

If you need to contact technical support...

Every system is different, so it is extremely helpful (if not necessary) for our support team to have photos of your setup to help troubleshoot a problem. Please be prepared to take any requested photos and send them to support@nomadiccooling.com.

You can initiate support requests by sending an e-mail to support@nomadiccooling.com. Or you can call (480) 576-2489. Our support team attempts to respond as soon as possible and we strive to always respond within 24 hours Monday through Friday.

