

MOONBOX

Assemble manual

Hello! Thank you for choosing our products. We put our hearts into making them, so we're even more delighted that you liked them. In the following instructions, you will find all the information you need.

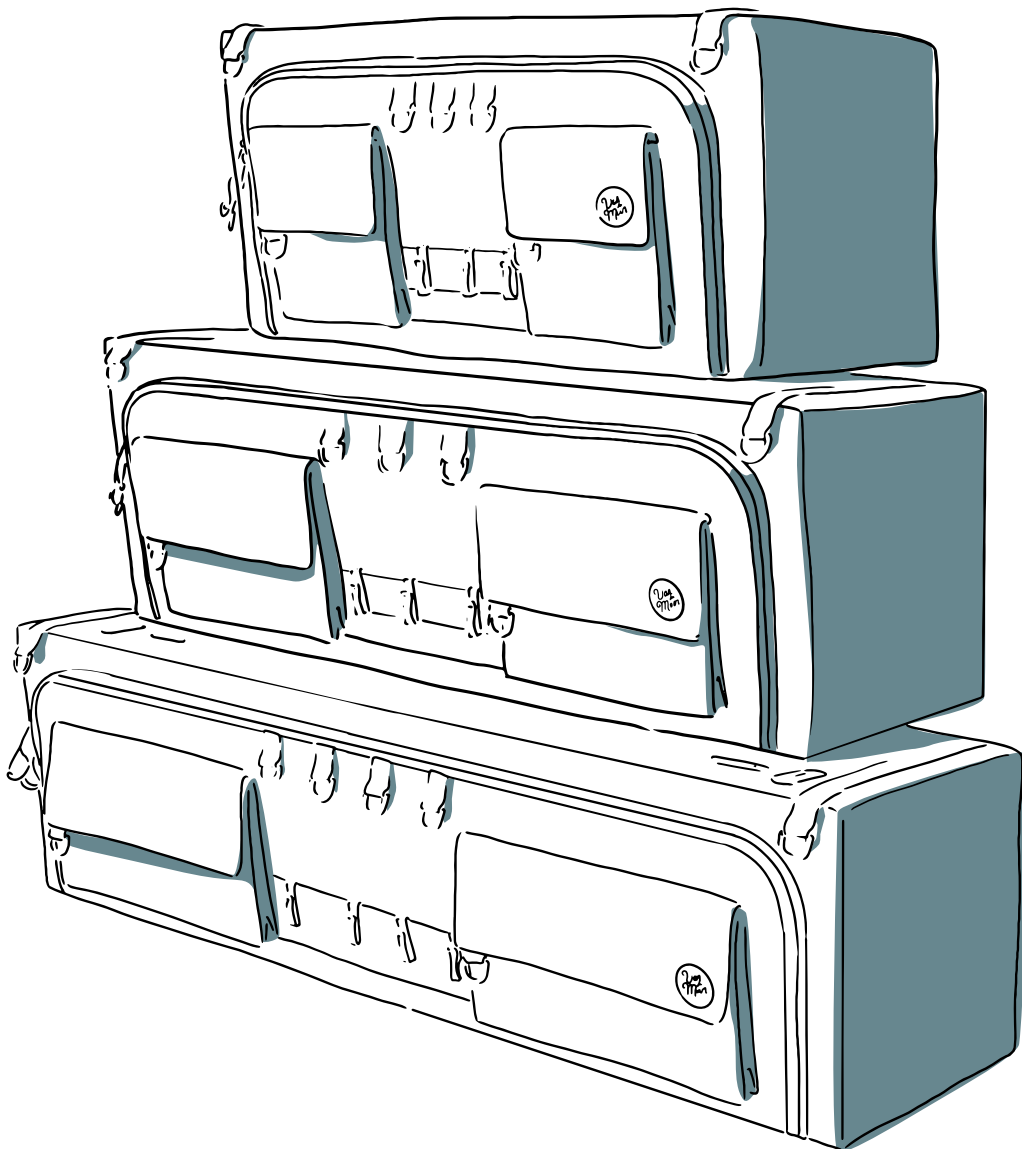

Live light at
vandermoon.com



Models:

Moon Box Standard

Moon Box Adventure



Since 1993, Vitberg has been producing medical devices for rehabilitation, treatment, cosmetology and sports.

Its products are known and appreciated.

Medicine and technology are not our only passion, we also love exploring the world.

We have translated the experience gained over the years into the production of accessories for people like us.

This is how the Van Der Moon brand was born.

Contents

General informations	4
Available versions	5
Maximum shelf load	6
Tools needed	7
Set of elements	7
Prepare your car to assembly Moon Box	8
I. Moon Frame	10
II. Moon Frame + Airline	12
III. Airline	15
Information regarding use	17

General **information**

Rigid wall-mounted van cabinets covered with fabric.

The construction of the Moon Box is made of high-quality aluminum and special, super-strong and ultra-light polypropylene chamber plates. The boards are resistant to temperatures, water, oils and chemicals. The connections are riveted and screwed and additionally reinforced with a layer of glue, thanks to which the structure becomes even more durable and resistant to any vibrations. The Moon Box construction is covered with an additional 0.5 cm foam coating, and the corners of the structure are reinforced to avoid any damage during possible mechanical operation. Depending on the size, the Moon Box has 2 shelves (Moon Box 50 and 70 cm) or 4 shelves (Moon Box 90 and 115 cm). The size of the shelves allows for easy storage of assortment of various sizes. In sizes 90 and 115, the space of the shelves is divided in half to strengthen the load capacity of the shelf and to divide the storage space. In the inner part of the Moon Box there are holders for mounting protective nets (Moon Safety) - these catches are made of aluminum sheet and painted with powder varnish. The Moon Box is trimmed with a durable technical fabric. The material is characterized by durability and high resistance to abrasion, tearing and mechanical actions, it is light and relatively stiff. It is made of polyester fibers that slightly absorb water, but thanks to the PVC-coated bottom layer, the fabric is waterproof. There are mounting holes on the structure, finished with plates specially designed for this purpose. The upper part of the cover is equipped with a handle for convenient carrying of the Moon Box.

Available colours:



Anthracite



Gray



Blue



Red



Green

Compatible car models:

Mercedes Sprinter 901
Mercedes Sprinter 902
Mercedes Sprinter 904 < 2006
Mercedes Sprinter 906
Mercedes Sprinter 907
Volkswagen Crafter I 2007-2016
Volkswagen Crafter II > 2016 only H3
Volkswagen LT < 2006
Volkswagen Transporter T5, T6, T6.1 to adapt
Ford Transit MK7 H2 < 2013
Ford Transit MK8 H2, H3 > 2013
Man TGE > 2017
RAM ProMaster > 2013
Fiat Ducato version III > 2006 H2
Citroen Jumper version II > 2006 H2
Peugeot Boxer version II > 2006 H2

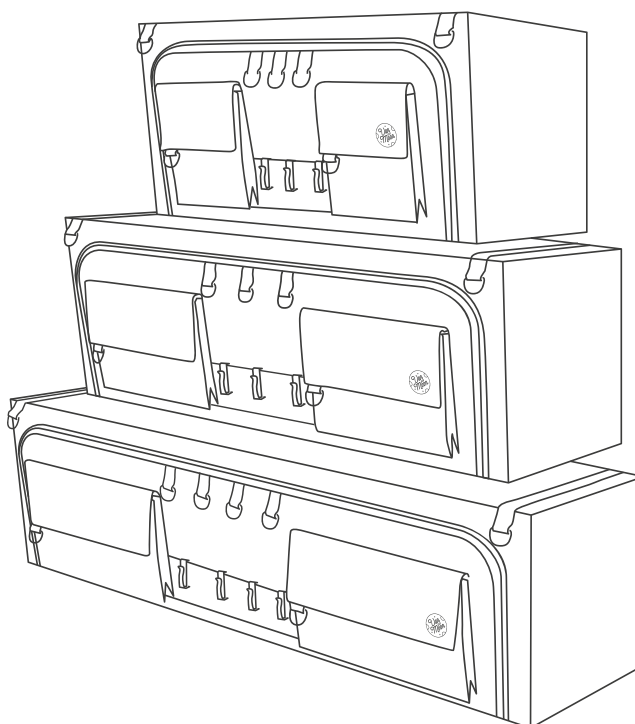

Available **versions**

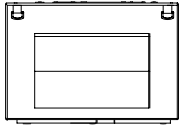

MOONBOX Standard 50

Size: 350x300x500 mm
Weight: 4,5 kg
Capacity: 64 l

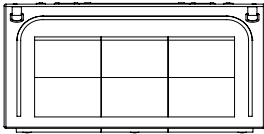

MOONBOX Standard 70

Size: 350x300x700 mm
Weight: 6,0 kg
Capacity: 90 l

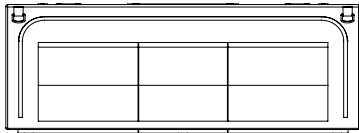

MOONBOX Standard 90

Size: 350x300x900 mm
Weight: 7,5 kg
Capacity: 118 l

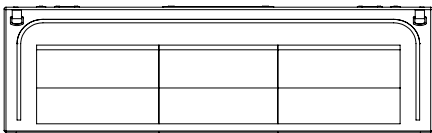

MOONBOX Standard 115

Size: 350x300x1150 mm
Weight: 9 kg
Capacity: 150 l

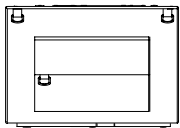

MOONBOX Adventure 50

Size: 350x300x500 mm
Weight: 4,5 kg
Capacity: 64 l

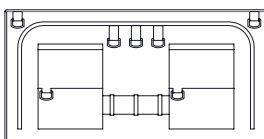

MOONBOX Adventure 70

Size: 350x300x700 mm
Weight: 6,0 kg
Capacity: 90 l

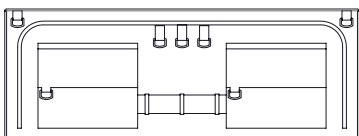

MOONBOX Adventure 90

Size: 350x300x900 mm
Weight: 7,5 kg
Capacity: 118 l

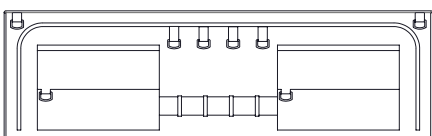

MOONBOX Adventure 115

Size: 350x300x1150 mm
Weight: 9 kg
Capacity: 150 l

Maksymalne obciążenie półek

MOONBOX
Standard/Adventure 50

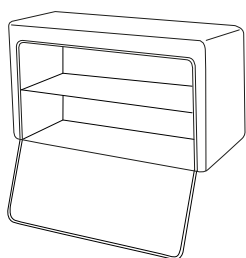

20
KG

55
KG

MOONBOX
Standard/Adventure 70

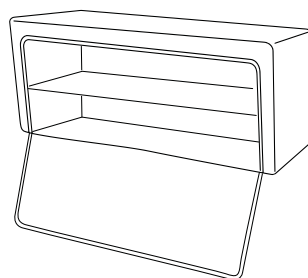

20
KG

50
KG

MOONBOX
Standard/Adventure 90

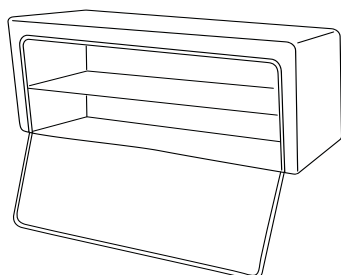

10
KG

10
KG

22
KG

22
KG

MOONBOX
Standard/Adventure 115

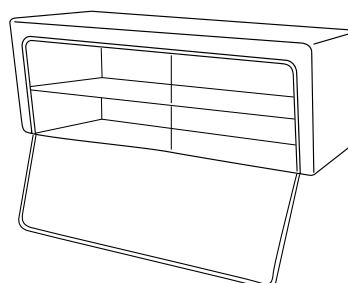

10
KG

10
KG

20
KG

20
KG

Tools **needed**



Drill



Riveting machine for blind rivets and/or riveting machines for rivet nuts



Flat-blade screwdriver

Set of **elements**



1A – MOONFIX

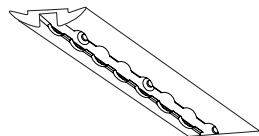

2 – Airline board



4A – Rivet nut M6



5A – Rivet nut M5



1B – MOONFIX

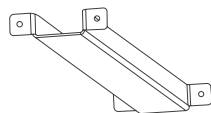

3 – MOONFRAME



4B – Bolt M6



5B – Bolt M5

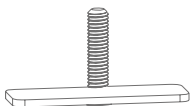

1C – MOONFIX



5C – Screw washer ø 5

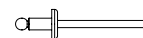

5D – Blind rivet

Prepare your car for assembly MOONBOX

MOONBOX can be assembled in three ways:

- I. using Moon Frame (3) to which M6 4 rivet nuts are screwed directly (using a sheet metals crewdriver) – **page 10**
- II. using Moon Frame with an additional Arline board – **page 12**
- III. only using Arline boards (without using Moon Frame 3) – **page 15**

IMPORTANT!

To fully load the Moon Box (as per the manufacturer's recommendations), you should use the first or second method (Moon Frame mounted to the vehicle's body). Mounting Airline rails will also transfer the full load, BUT ONLY if they are attached to the vehicle's body using rivet nuts or removable rivets (when mounting on sheet metal screws or wood screws, respectively, for sheet metal, plywood, and/or other materials, the manufacturer is not responsible for the load-bearing capacity of these connections).

MOONFRAME assembly

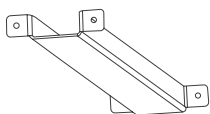

3 – Moon Frame

Moon Frame(3) is a structural reinforcement used to mount the Moon Box, Airline boards or other suspended accessories.



5A – Rivet nut M5 x4

Moon Frame (3) crossbars to the car body should be fastened on M5 (5A) rivet nuts and M5 bolts (5B) and screw washers (5C) (to protect against unscrewing) or on blind rivets \varnothing 5 (5D).



5B – Bolt M5 x4



5C – Screw washer \varnothing 5 x4



5D – Nit zrywalny x4

Moon Frame are not included in the set, you can purchase them separately on our website.



Place the Moon Box in the desired location inside the car. Through the upper mounting hole, mark a line on the vehicle's body using a pencil. To the marked line, add the thickness of the upholstery that you will be mounting, and move the marking inwards towards the cabin by that thickness. In the marked location, attach the Moon Frame or AirLine strips in such a way that the marked line is in the center.

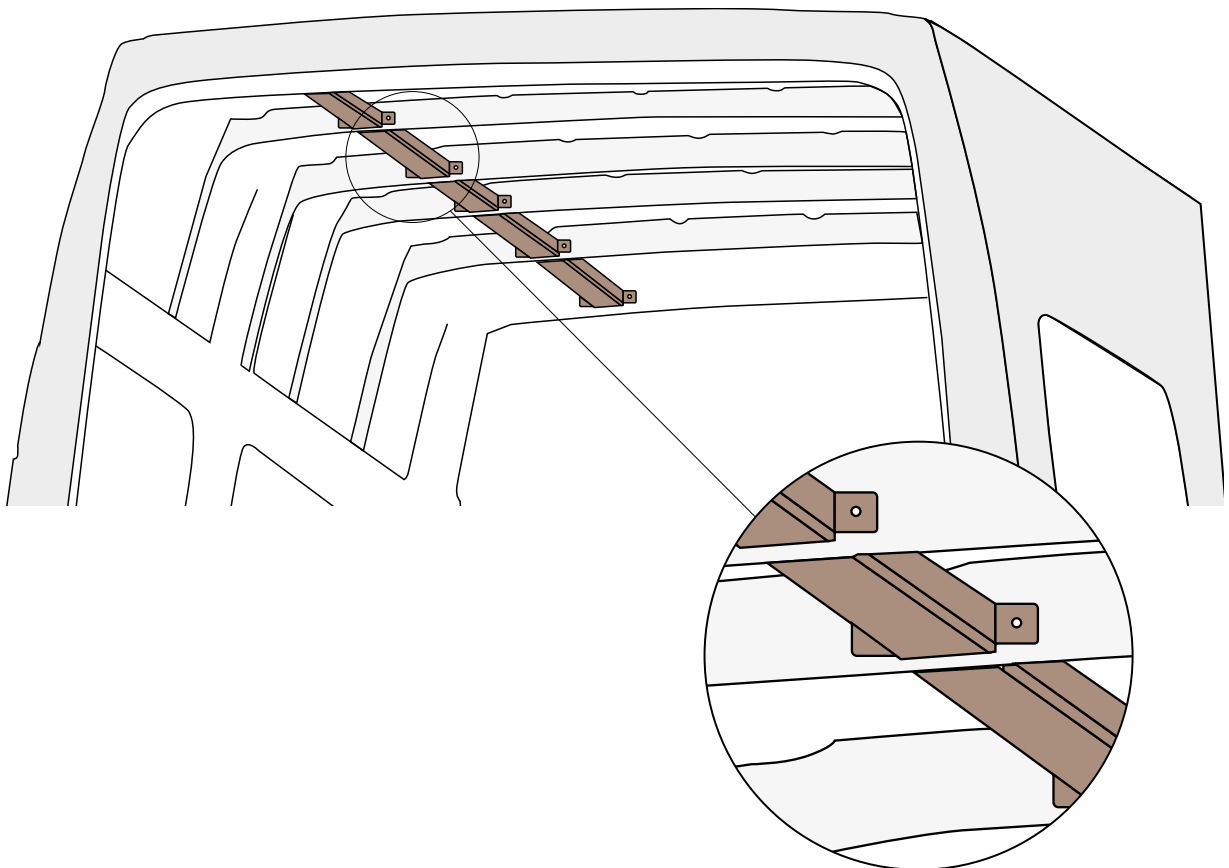
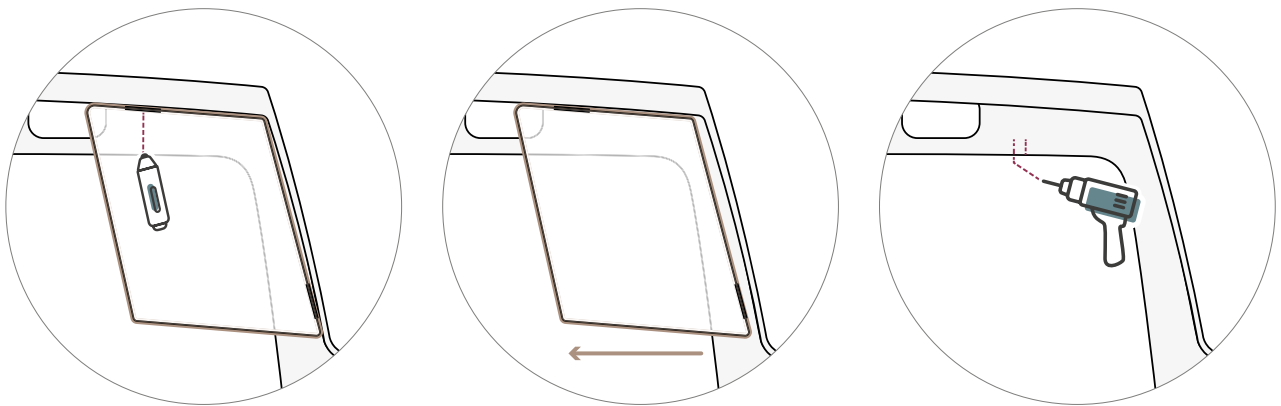

I. MOONFRAME + MOONBOX

Step 1

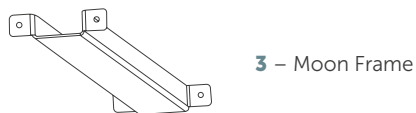

Mount the Moon Frame (3) reinforcement bars to the vehicle body. Install the ceiling and wall covering (finishing elements not included).

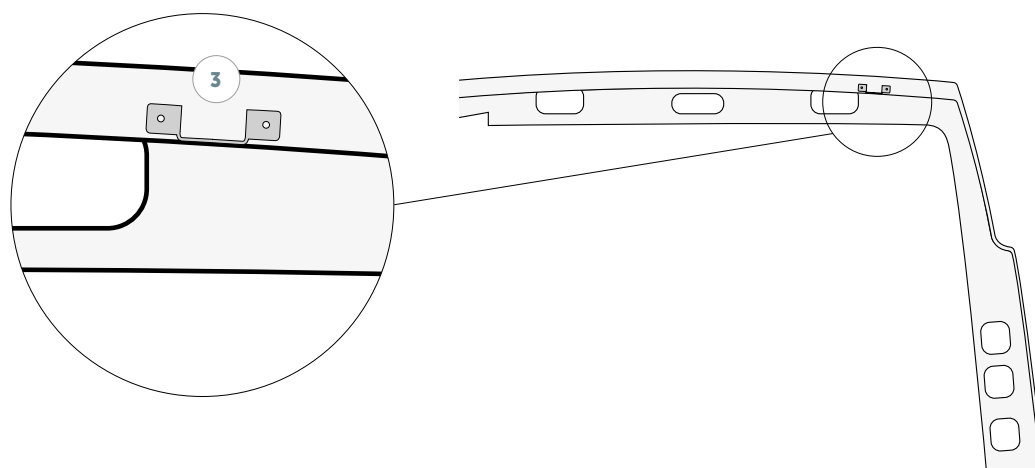

Step 2

Set the Moon Box in the target place so that the mounting holes coincide with the previously installed crossbars (3) and mark the places of the holes. The upper mounting holes are to be drilled in the Moon Frame (3) crossbars. The lower mounting holes are to be drilled in the original body reinforcement.

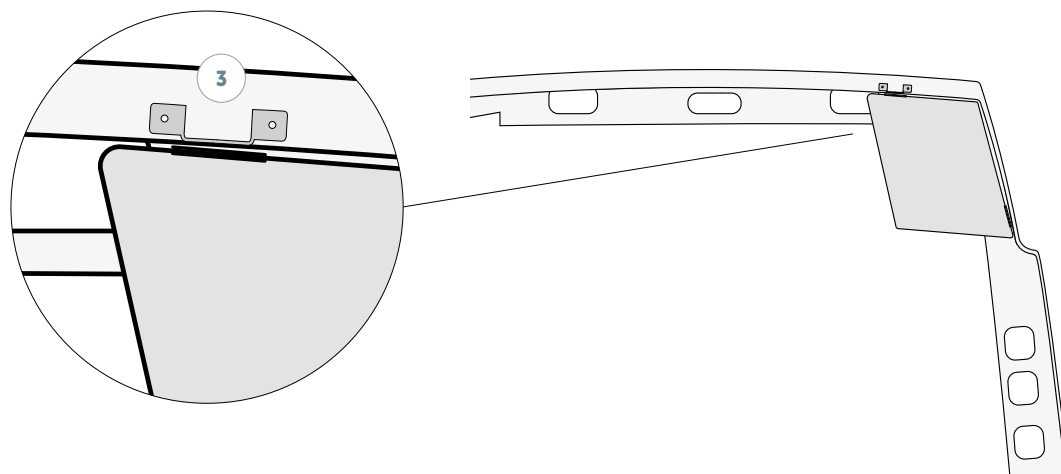

Step 3



4A – Rivet nut M6 x4



4B – Bolt M6 x4

Rivet the rivet nut into the drilled holes **4A**

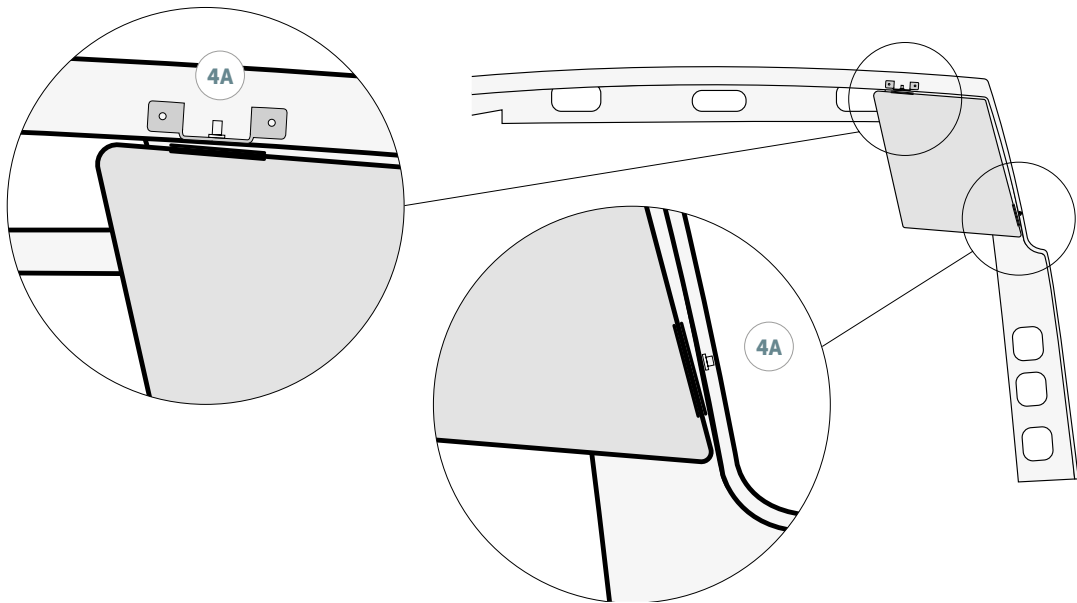

Step 4

Apply the Moon Box to the car body in accordance with the drilled holes, screw the element to the structure with M6x40 **4B** screws through the mounting holes in the Moon Box

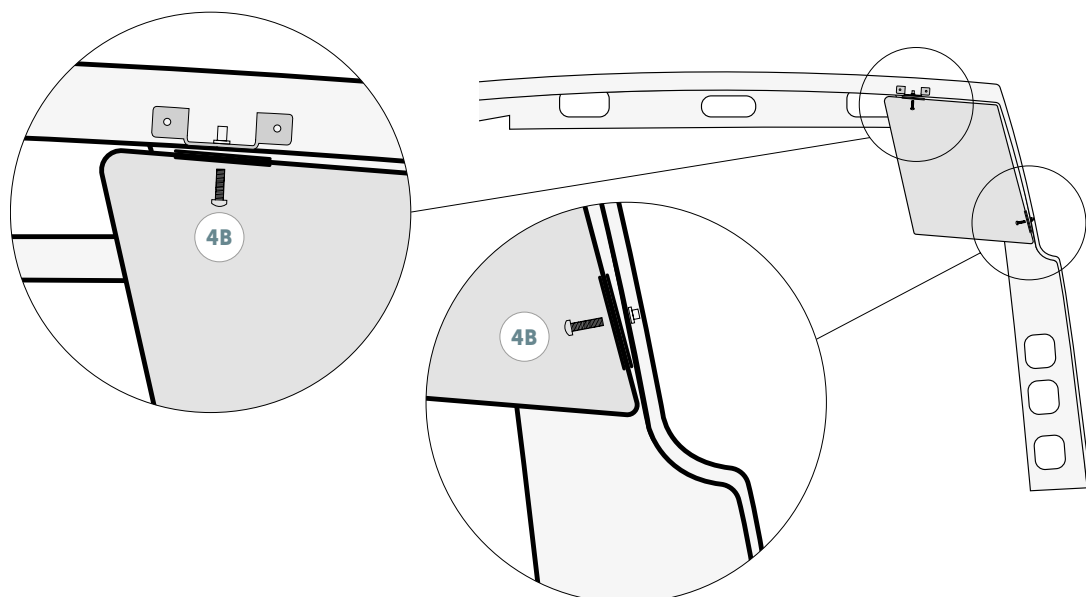

II. MOONFRAME + Airline + MOONBOX

Set of mounting elements for Airline board.

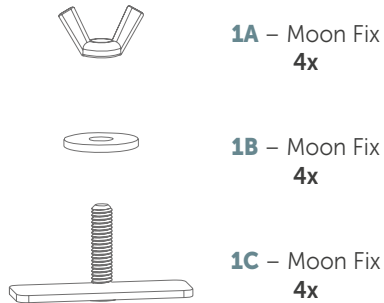

Moon Fix – is a set of mounting screws used in the Moon Box installation system.

Moon Fix fits all versions of Moon Box.

In set you will find 4 bolts (mounting bolts M6x40, are equipped with a steel element inserted into the Airline board) **1C**, 4 wing nuts M6 **1A** i 4 round washers **1B** (M6/140HVwhite galvanized).

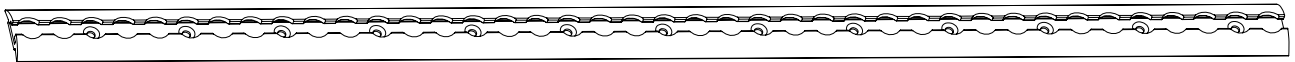

2 – Airline board (It is not included in the set) **2x**

Each Moon Box has mounting holes on the back and top. The holes have been prepared for the use of Moon Fix **1** bolts or rivet nuts M6 - **4A** with a bolt M6 - **4B**.

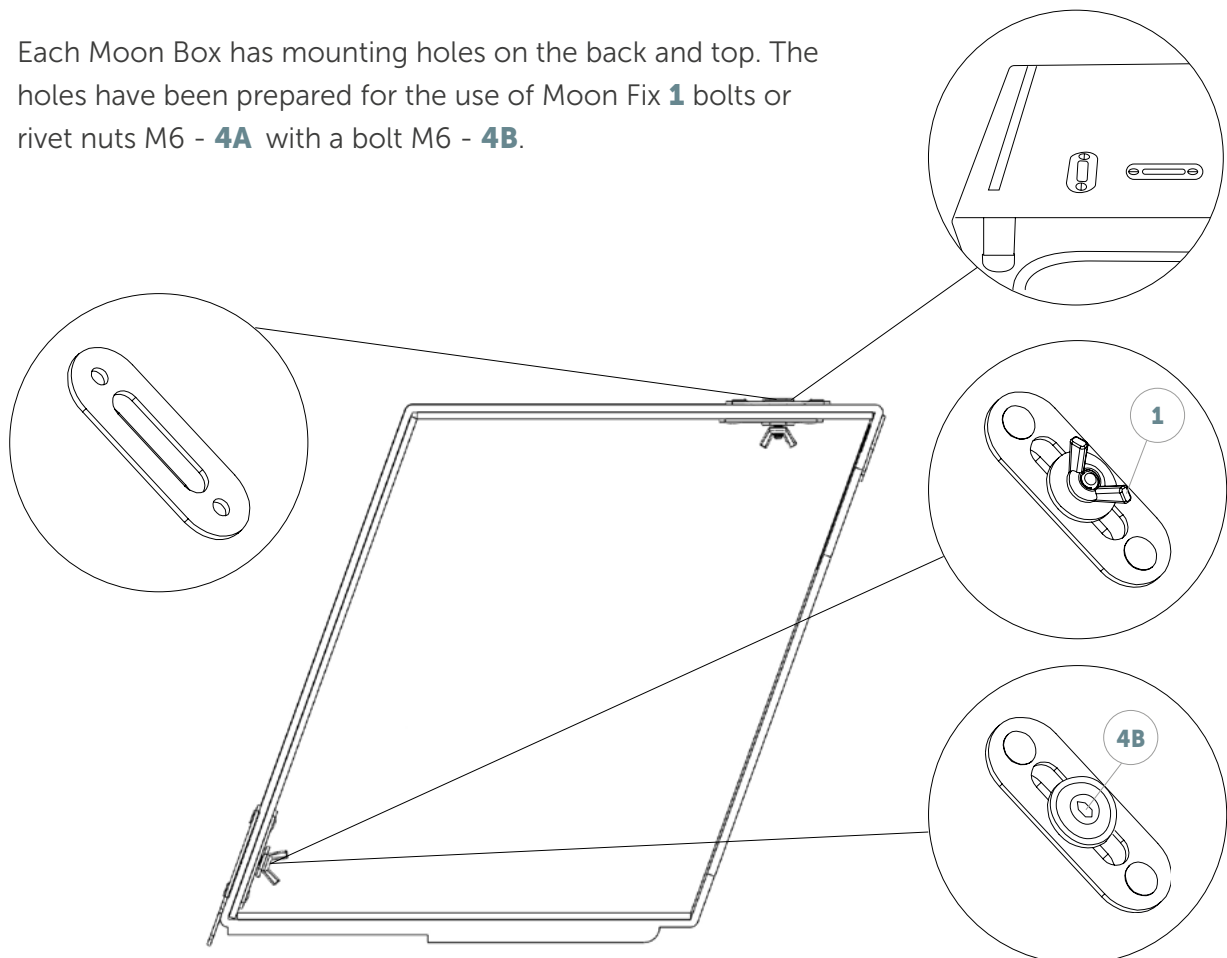

Moon Box cross-section - side view.

Step 1

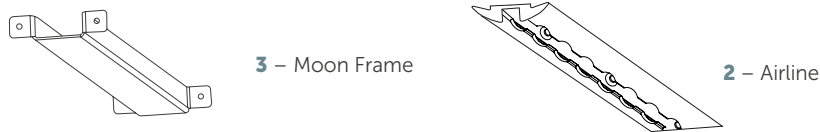

Mount the Moon Frame reinforcement bars (3), to the vehicle's body, to which the Airline board (2) will be attached in subsequent steps. Install the ceiling and wall covering. Finishing elements, reinforcing crossbars and Airline strips are not included in the set.

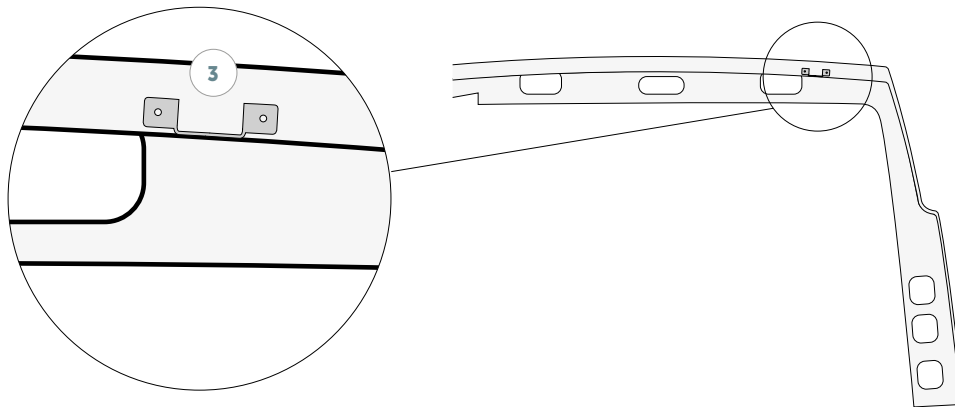

Step 2



Set the Moon Box in the target place so that the mounting holes coincide with the previously installed crossbars (3) and mark the places of the holes. The upper mounting holes are to be drilled in the Moon Frame (3) crossbars. The lower mounting holes are to be drilled in the original body reinforcement.

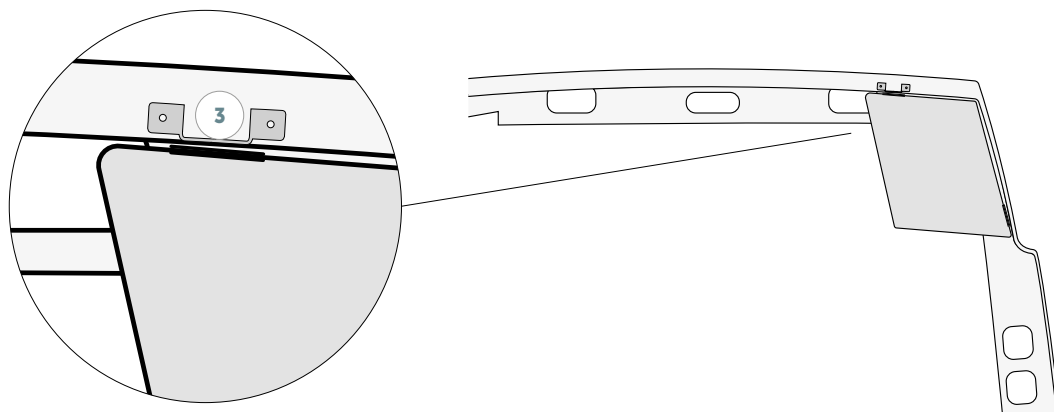

Step 3

Screw the Airline boards to the previously installed reinforcing bars. The connection must be solid and durable. Insert Moon Fix **1C** screws into the mounted Airline board **(2)**. The number of prepared screws must correspond to the number of mounting holes in the planned Moon Box installation.

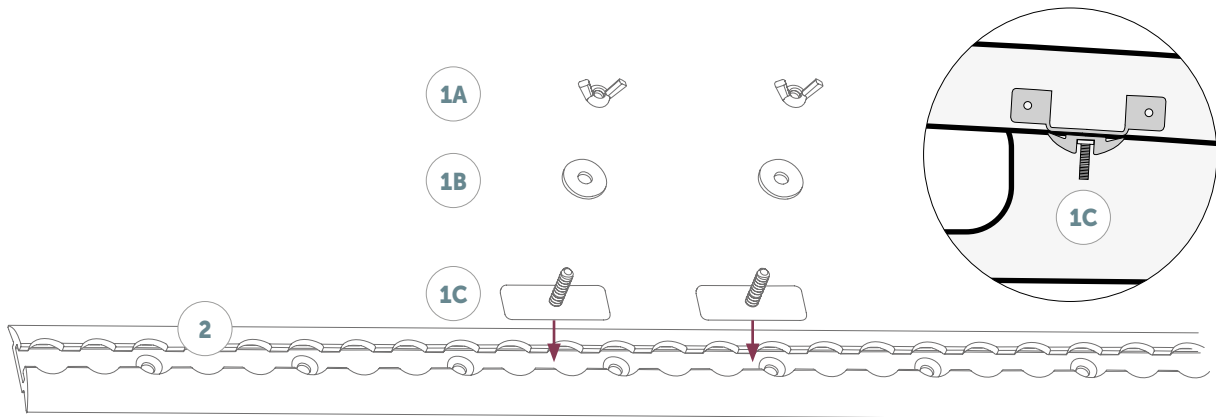

Step 4

Attach the Moon Box to the Airline boards **2** by inserting the Moon Fix **1C** bolts through the mounting holes and tightening the wing nuts **1A** and washers **1B** from the inside of the Moon Box.

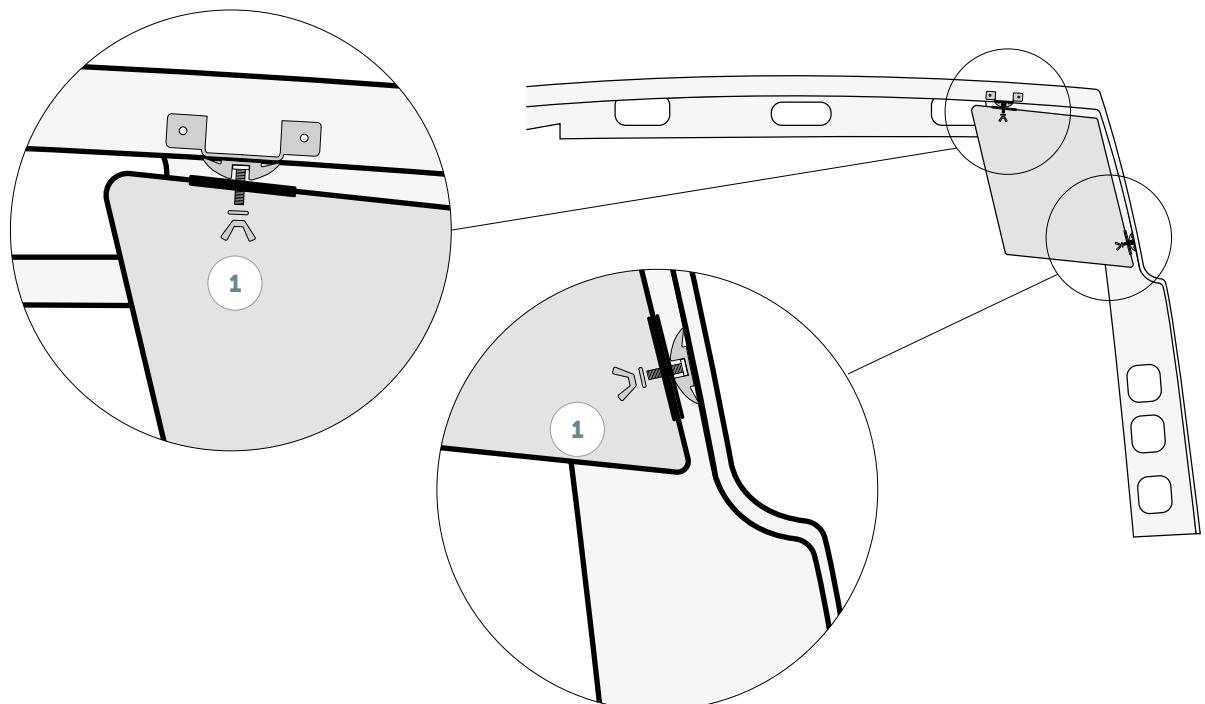

III. Airline + MOONBOX

Step 1

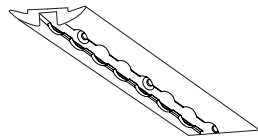

2 – Airline



4A – Rivet nut M6 x4

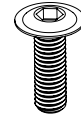

4B – Bolt M6 x4

Fasten Airline **2** to the car body with M6 rivet nuts **4A** and M6 countersunk bolts **4B**.

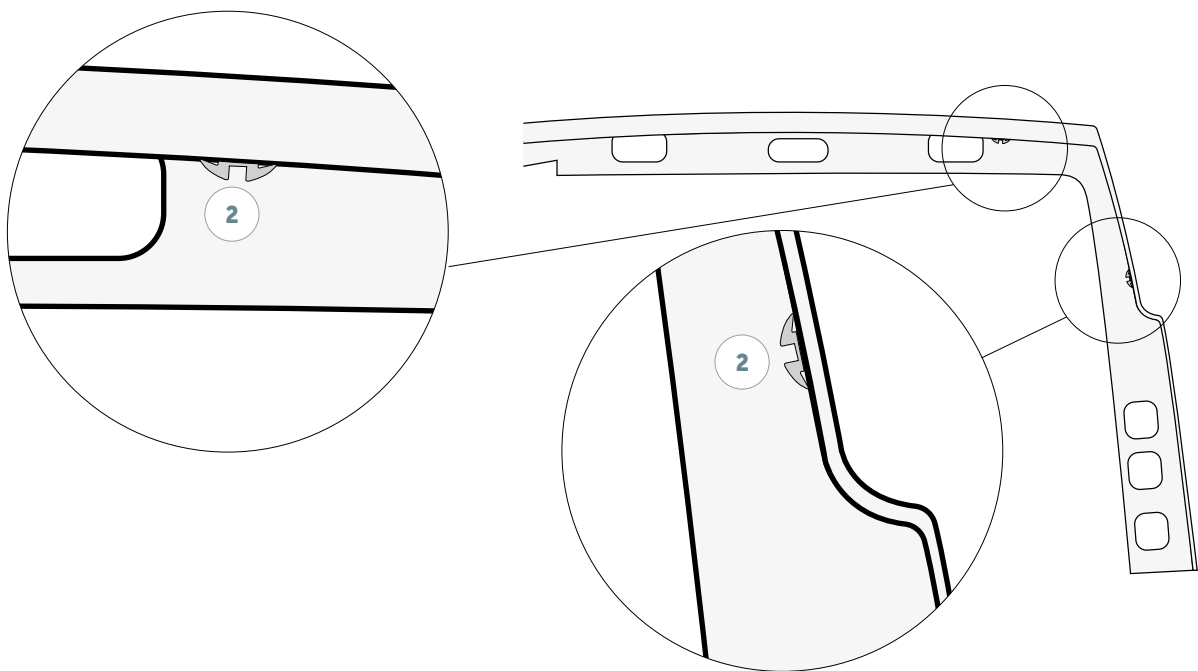

Step 2

Insert the Moon Fix **1C** screws into the installed Airline boards **2**. The number of prepared bolts must correspond to the number of mounting holes in the Moon Box planned to be installed.

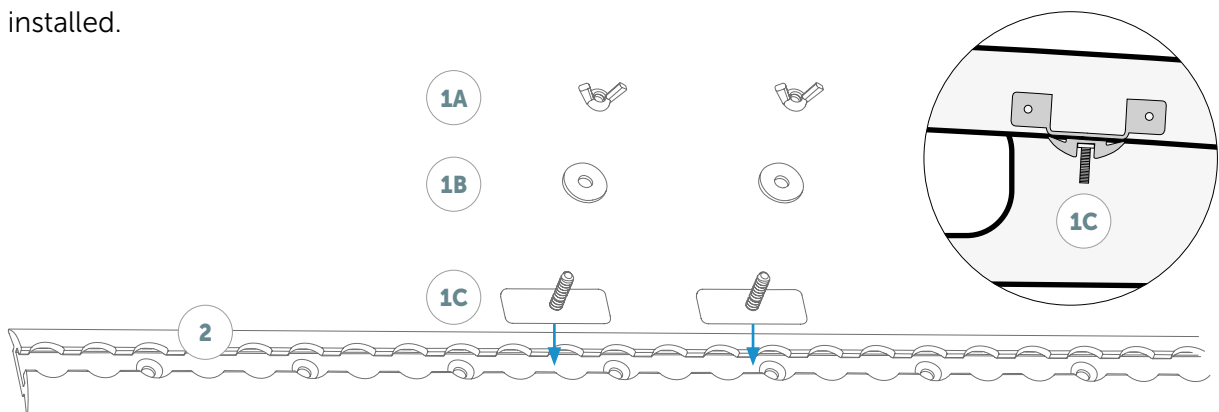

Step 3

Attach the Moon Box to the Airline boards **2** by inserting the Moon Fix **1C** bolts through the mounting holes and tightening the wing nuts **1A** and washers **1B** from the inside of the Moon Box.

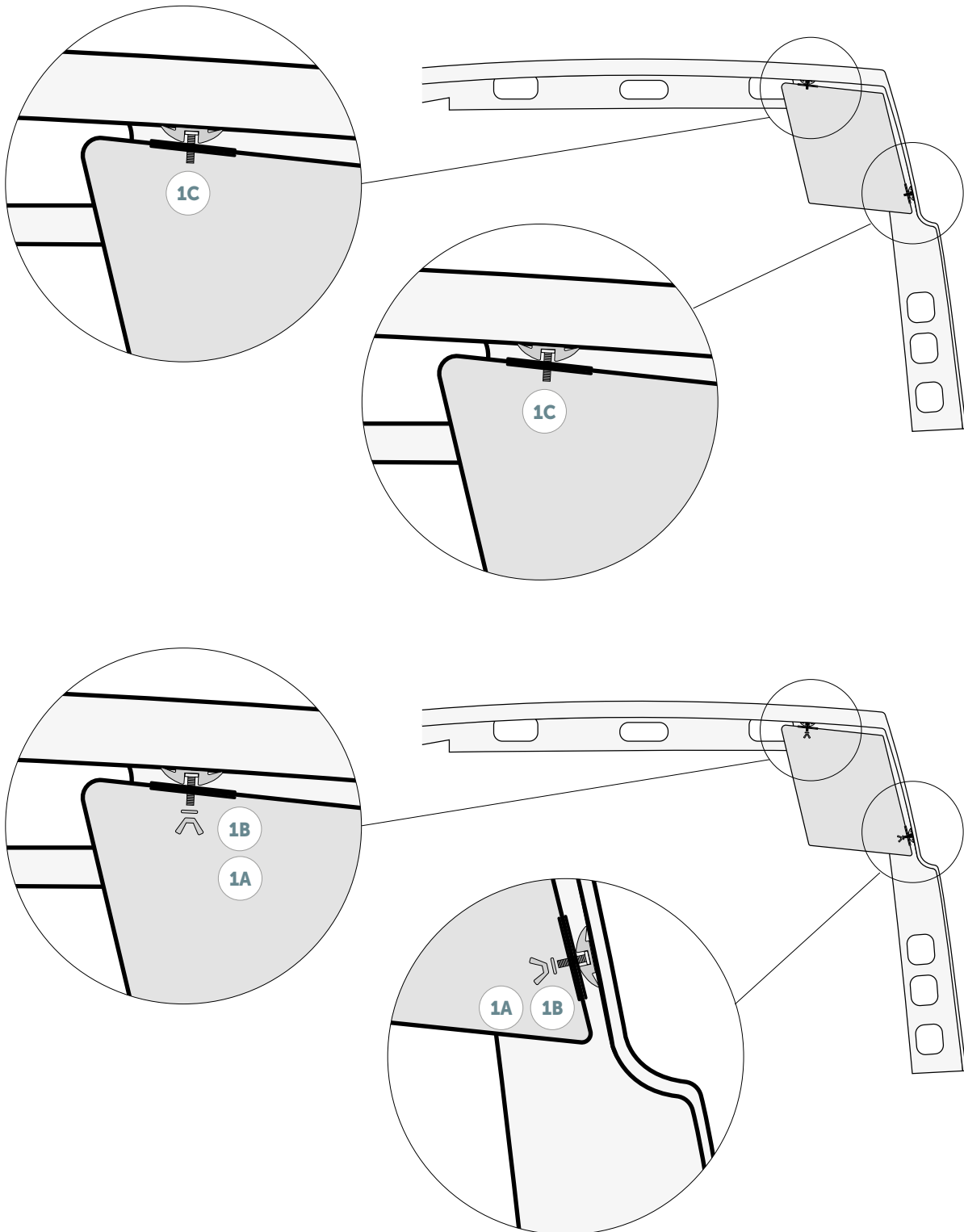

Information **regarding use**



Cleaning

Handwash. Rinse the soiled area thoroughly with clean water and wipe it with a sponge gently using a mild detergent.

Do not use bleach, iron or heat drying. The product is not machine washable. Before cleaning, remove all elements from the inside of the Moon Box along with the shelf.

Metal parts should be dry cleaned.



Composition

poliester 100%, coating PVC-FLAT, aluminium, polypropylene plate



Transport and storage

The products are packed in cardboard outer packaging.

During transport, they should be placed horizontally or vertically.

Must be transported in the original packaging.



Disposal of the packaging

The packaging is made of recyclable cardboard, so it should not be thrown away, but stored in a landfill in waste paper bins or special containers for cardboard packaging.



Precautions

Please make sure you have read and understood the instructions before using the Moon Box.

After installation, it is recommended to check the mounting of the Moon Box by pulling the entire structure firmly.

Do not leave the Moon Box in direct sunlight - it may cause fading of the material. This does not change the mechanical properties of the material.

Do not use open fire near the Moon Box.

Protect against moisture.

Do not load the Moon Box beyond the recommended maximum weight.

Do not use any sharp objects such as knives, screwdrivers, etc. to remove the outer packaging.

The exact specifications, dimensions, capacity, and load-bearing capacity, with distinctions for different versions, are detailed in the Moon Box Product Sheet, available for download on the www.vandermoon.com website.





www.vandermoon.com



Contact

tel. +48 18 442 33 69
shop@vandermoon.com

Van der Moon® is a registered trademark of the Vitberg Sikora Jacek. ©
Vitberg Sikora Jacek – all rights reserved.
Made in Poland.
