

Everywhere, that's where I want to go



# VAN 2024 CATALOGUE VAN CONVERSIONS AND CAMPERVANS

For van conversions and campervans

[fiamma.com](https://fiamma.com)



# For 75 years quality and technology on the road

**Founded in Italy in 1945, Fiamma is an international leader in the development of technical accessories to convert your vehicle into the ideal vehicle for every adventure. Its products offer you technology and quality without boundaries.**

Travelling on board a motorhome is the best way to get to know the world. In absolute freedom, you can decide when to leave and where to stop. With friends or family, by the sea or at the foot of a mountain, you can imagine the trip you want, if your vehicle has Fiamma products.

The quality of each item, tested in the laboratory and then on the road, along with professional assistance always available will make every trip an unforgettable moment of dolce vita.

FIAMMASTORE		CARRY-BIKE		COMFORT	
.....					
<b>Awnings</b>	3	<b>Bike carriers</b>	37	<b>Comfort</b>	54
Winch awnings - wall installation	4	Campervan	38	Rooflights	55
Winch awnings - roof installation	10	Van conversion	46	Lighting	58
Manual awnings	16	Accessories	51	Water	61
Motor-Kit	18			Level systems	64
Awning accessories	19			Organisation	65
				Ladders	68
<b>Panels and enclosures</b>	20			Vehicle covers	70
Sides and Fronts	20			Safety	71
Enclosures	24			Hygiene - Mix	71
Enclosure for roof	32				
Rear door enclosures	34				
Skirting for wind protection	35				
Enclosure accessories	35				



## **FIAMMASTORE**

With Fiamma, home is wherever you decide to go. Get on board of your vehicle and discover the world! Fiammastore products are the ideal travel companions for your holidays, trips, excursions and adventures. Whatever vehicle you have, in just a few moments you can enlarge the space at your disposal and transform it into an environment that you will immediately call "home".

Awnings, Blockers and Privacy Rooms make you feel protected wherever you decide to stop. Start planning your next trip: with Fiamma, "home is everywhere".

# The world is your home



# F45s

SUITABLE FOR VAN CONVERSIONS AND CAMPERVANS



The original wall-mounted awning, practical, robust, functional and versatile, it is the best value for money.



**FEATURES:**

- Winch awnings for wall installation with practical visible loop
- Standard brackets included. Brackets are optionally available for most minivans and van conversions currently on road
- Length from 190 to 400

**F45s campervan** - These special versions of our F45 awning are complete with an installation kit and are suitable for many types of minivan:

- VW T5 / T6 / T6.1
- PSA group

VW version also suitable for short and long wheelbase multivan (Volkswagen transporter with C-rail) and California. PSA version also for lift roof models.



**F45s CAMPERVAN**

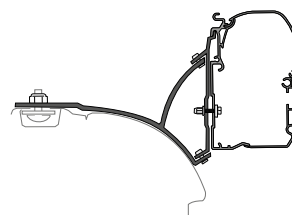

F45s VW T5/T6

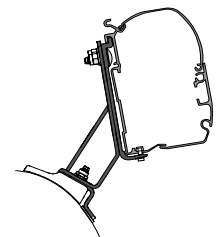

F45s PSA



**Visible loop**  
For maximum ease of use



**Dual Shock-Absorber**  
Absorbs shocks in case of heavy stress

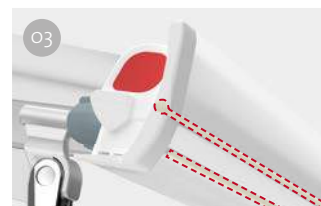

**Double guide**  
To install a front panel or Privacy and other accessories



**Telescopic Leg**  
Equipped with a reinforced joint





**+** COMPLETE YOUR F45s WITH SIDE AND FRONT PANELS

Blocker / Blocker Pro

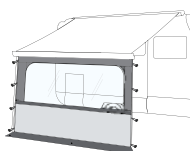

Sun View XL

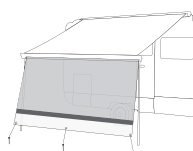

Side W Pro / Shade

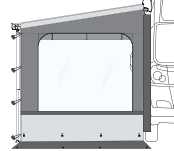

Side Block <sup>new 2024</sup>

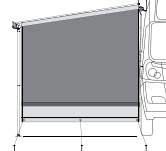

Sun View Side

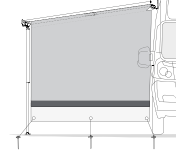

**+** COMPLETE YOUR F45s WITH ENCLOSURES

Privacy Room

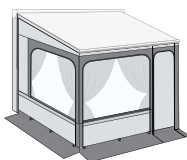

Privacy Room Light

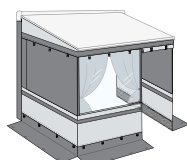

Privacy Ultra Light

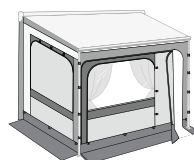

**+** MOTORISABLE

Motor Kit Compact F45s with wall control Control System

Motor Kit Advanced F45s awning and LED management via Fiamma app, Control System wall button

**+** COMPLETE YOUR F45s WITH LED

Awning Arms LED



Kit Awning LED



LED Awning Case



**+** ACCESSORIES  
– See page 18-19

**MODELS AND DIMENSIONS**

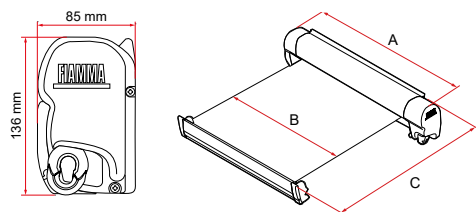

**CASE BOX**

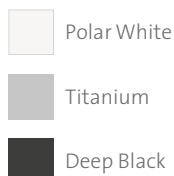

**FABRIC**

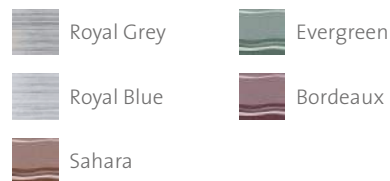

F45s	Length A	Length B	Extension C	Shade Surface	Weight	Fabric colours	Item No. Polar White***	Item No. Titanium	Item No. Deep Black
190 *	185cm	169cm	100cm	1,7m <sup>2</sup>	11,5kg	R-Q	06280M01(X)	06290M01(X)	06759M01R
230	231cm	214cm	150cm	3,2m <sup>2</sup>	16,5kg		06280P01(X)	06290P01(X)	06759P01R
260	263cm	247cm	200cm	4,9m <sup>2</sup>	19,5kg		06280H01(X)	06290H01(X)	06759H01R
300	308cm	292cm		7,3m <sup>2</sup>	23,0kg		06280A01(X)	06290A01(X)	06759A01R
325	323cm	307cm		7,7m <sup>2</sup>	24,0kg		-	-	06759U01R
350	348cm	331cm	250cm	8,3m <sup>2</sup>	25,0kg		06280B01(X)	06290B01(X)	06759B01R
375	375cm	357cm		8,9m <sup>2</sup>	26,0kg		06280S01(X)	06290S01(X)	06759S01R
400 **	398cm	381cm		9,5m <sup>2</sup>	27,0kg		06280C01(X)	06290C01(X)	06759C01R

The awning is delivered as standard with installation kit. \* Awning for the main door, comes without vertical support legs. \*\* 1 Tension Rafter made of anodized aluminium included. \*\*\*Ask your local dealer for availability and timing of the Sahara (S), Evergreen (E), Bordeaux (D) fabric versions. Specify the fabric colour you want when ordering by replacing (X) with: R=Royal Grey, Q=Royal Blue. For RHD vehicles available on request the left version awning with winch installed on the left side, case in Polar White and canopy in Royal Grey.

**MODELS AND DIMENSIONS**

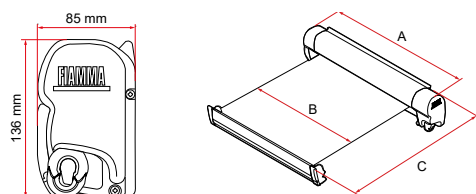

**CASE BOX**

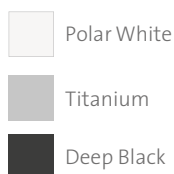

**FABRIC**



F45s VW T5 / T6	Length A	Length B	Extension C	Shade Surface	Weight	Item No. Polar White	Item No. Titanium	Item No. Deep Black
260 - VW T5 / T6 C	263cm	247cm		4,9m <sup>2</sup>	19,5kg	06280E01R	06290E01R	06759E01R
260 - VW T5 / T6 M / T						-	06290D01R	06759D01R
260 - VW T5 / T6 M / T - RHD	308cm	292cm	200cm	7,3m <sup>2</sup>	23,0kg	-	06291D01R	07129D01R
300 - VW T5 / T6 M / T - Long	308cm	292cm		7,3m <sup>2</sup>	23,0kg	-	06290R01R	06759R01R
300 - VW T5 / T6 M / T - Long - RHD	308cm	292cm		7,3m <sup>2</sup>	23,0kg	-	06291R01R	07129R01R

M: Multivan T:Transporter C: California Long = long wheel base

F45s PSA	Length A	Length B	Extension C	Shade Surface	Weight	Item No. Polar White	Item No. Deep Black
260	263cm	247cm	200cm	4,9 m <sup>2</sup>	19,5kg	06280F01R	06759F01R







# F43van

new  
20  
24

SUITABLE FOR CAMPERVANS



Wall-mounted winch awning, specifically designed for campervans. Compact and innovative design, it perfectly matches the shape and aesthetics of campervans, even those with pop-up roofs.



**FEATURES:**

- Opening via winch with magnetic catch which is concealed in the cover, conveniently positioned due to the awning's mounting height on the van
- Awning opening with negative inclination to use the space at full height (max. 2.20 m)
- LED provision in the case box, recessed front closure
- The compact shape of the awning once installed reduces the maximum height from the ground, granting access to parking spaces
- Lengths 270 and 300

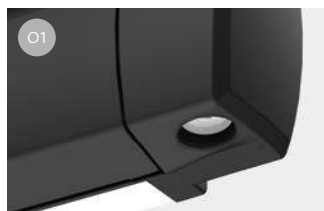

**Magnetic attachment**  
For opening the awning, concealed in the cap cover



**LED preparation**  
Integrated in the box, to illuminate the space

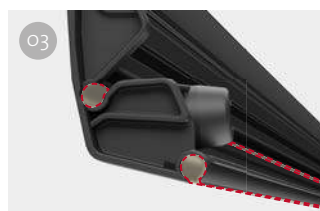

**Guides**  
Concealed, for installation of the Room Van Premium or other accessories

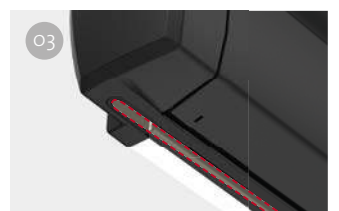

MODELS AND DIMENSIONS

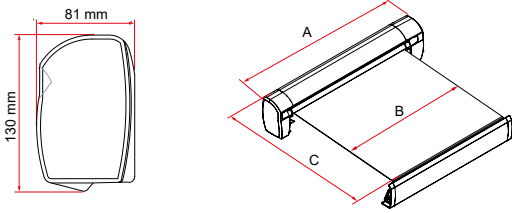

F43van	Length A	Length B	Extension C	Shade Surface	Weight	Item No.
270	270cm	257cm	225cm	6,9m <sup>2</sup>	19,0kg	08833A01R
300	310cm	287cm	250cm	8,9m <sup>2</sup>	21,5kg	08833B01R

CASE BOX

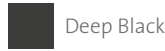

FABRIC



COMPLETE YOUR F43VAN WITH SIDE AND FRONT PANELS

Blocker / Blocker Pro

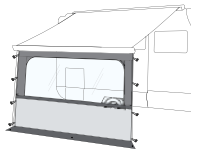

Sun View XL

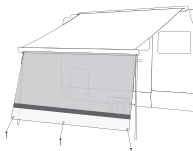

Side W Pro

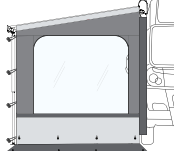

Side Block <sup>new 2024</sup>

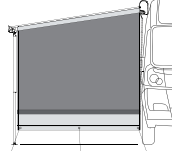

COMPLETE YOUR F43VAN WITH ENCLOSURES

Room Van Premium

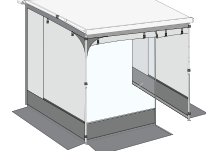

OPTIONAL - RAFTER LED VAN

Rafter for an optimally stretched fabric. It guarantees greater wind resistance and prevents the formation of water pockets in the event of rain, thanks to its installation perpendicular to the arms of the awning. It comes with LEDs to illuminate your holiday space.







# F80s

SUITABLE FOR VAN CONVERSIONS



The strengths of this awning are the triple guide on the front and the double LED arrangement. Elegant and minimalist in design, it blends in perfectly with the vehicle's silhouette.



**FEATURES:**

- Winch awnings for roof installation with practical visible loop
- Dedicated optional brackets for all van conversions
- Length from 290 to 400

**F80s Ducato** - Specific version of awning F80s for Ducato in lengths 320, 370 and 400 with Deep Black finish, complete with brackets, gasket and cover.



**Visible loop**  
For maximum ease of use



**Dual Shock-Absorber**  
Absorbs shocks in case of heavy stress



**Double LED preparation**  
Front and case box, LED light visible even when the awning is closed

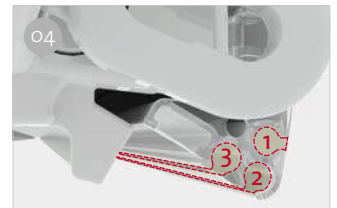

**Triple guide**  
To install a front panel or Privacy and other accessories







### KIT TELESCOPIC RAFTER ARM

Telescopic arm support: new optional accessory that can be installed on the F80s (from length 320)\* awnings to guarantee maximum stability. It prevents the arms from closing, whatever the weather conditions\*\*, guaranteeing resistance even under heavy stress. The F80s awnings will have their arms prepared to accommodate this new accessory.

new  
20  
24



	Weight	Item No.
Kit Telescopic Rafter Arm F80s <b>[New]</b>	0,2kg each	08832-01-

\* ensure that the awning is fitted with arms designed to receive the accessory  
 \*\* however, conscientious use is recommended, avoiding exposure to the risk of weather events for which a weather alert has been issued by the appropriate authorities.

### + COMPLETE YOUR F80s WITH SIDE AND FRONT PANELS

Blocker / Blocker Pro

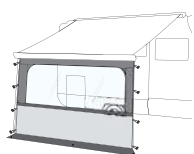

Sun View XL

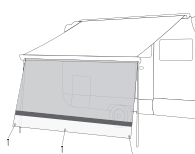

Side W Pro / Shade

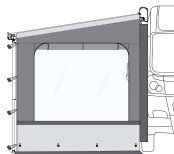

Sun View Side

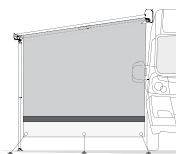

Side Block

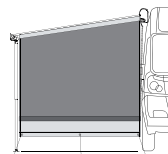

new  
20  
24

### + ACCESSORIES – See page 18-19

### + COMPLETE YOUR F80s WITH ENCLOSURES

Privacy Room

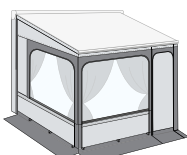

Privacy Ultra Light

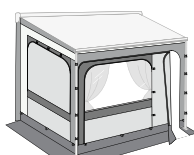

### + MOTORISABLE

Motor Kit Compact F80s  
with wall control Control System

Motor Kit Plus F80s  
with infrared remote control  
and wall control Control System

### + COMPLETE YOUR F45s WITH LED

Awning Arms LED



Kit Awning LED



Kit LED Strip Awning



Motor Kit Advanced F80s  
awning and LED management  
via Fiamma app, Control System  
wall button

MODELS AND DIMENSIONS

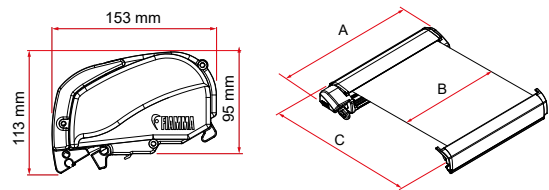

F80s	Length A	Length B	Extension C	Shade Surface	Weight	Item No. Polar White	Item No. Titanium	Item No. Deep Black
290	290cm	278cm	200cm	5,6m <sup>2</sup>	27,0kg	07830A01(X)	07832A01(X)	07831A01R
320	320cm	308cm	250cm	7,7m <sup>2</sup>	29,0kg	07830B01(X)	07832B01(X)	07831B01R
340	340cm	328cm		8,2m <sup>2</sup>	30,0kg	07830C01(X)	07832C01(X)	07831C01R
370	370cm	358cm		9,0m <sup>2</sup>	32,0kg	07830D01(X)	07832D01(X)	07831D01R
400 *	400cm	388cm		9,7m <sup>2</sup>	34,0kg	07830E01(X)	07832E01(X)	07831E01R

\*1 Tension Rafter made of anodized aluminium included.  
Specify the fabric colour you want when ordering by replacing (X) with: R=Royal Grey, Q=Royal Blue

CASE BOX

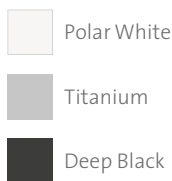

FABRIC

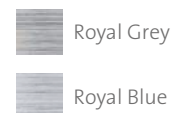

MODELS AND DIMENSIONS

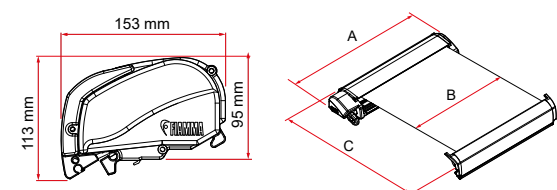

F80s Ducato	Length A	Length B	Extension C	Shade Surface	Weight	Item No.
320	320cm	308cm	250cm	7,7m <sup>2</sup>	29,0kg	07831N02R
370	340cm	358cm		8,2m <sup>2</sup>	30,0kg	07831P02R
400	370cm	388cm		9,0m <sup>2</sup>	32,0kg	07831Q02R

Delivered as standard with installation kit and gasket

CASE BOX

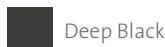

FABRIC



F80S DUCATO - COMPATIBLE VEHICLES

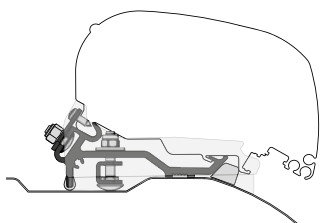

Brand	Model	Year	Height H2	Vehicle Length L2	Vehicle Length L3	Vehicle Length L4
Fiat	Ducato III-IV series	≥ 2006	2524mm	5413mm	5998mm	6363mm
Citroën	Jumper II-III series					
Peugeot	Boxer II-III series					









# F40van

SUITABLE FOR CAMPERVANS



Thanks to its small footprint and integrated brackets, it integrates perfectly into the vehicle and is quick and easy to remove.



**FEATURES:**

- Winch awnings for roof installation with practical visible loop
- Several types of dedicated brackets are available as options: PSA Group, VW T5/T6, Renault Trafic, Nissan NV 350, Ford Custom and Mercedes V Class
- Maximum leg height of 220cm makes maximum use of the awning height
- Not suitable for vehicles with lift roof
- Length 210 and 270



**Visible loop**  
For maximum ease of use



**Brackets**  
Brackets and adapters for every type of vehicle



**Arms**  
Reinforced and with reduced section

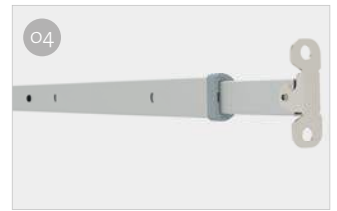

**Legs**  
With predefined position for fast and precise opening

**MODELS AND DIMENSIONS**

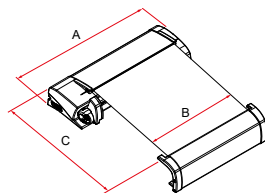
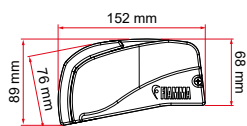

**CASE BOX**

Deep Black

**FABRIC**

Royal Grey

F40van	Length A	Length B	Extension C	Shade Surface	Weight	Item No.
210 <b>[New]</b>	210cm	199cm	150cm	2,9m <sup>2</sup>	17,0kg	07503Q01R
270	270cm	257cm	225cm	5,8m <sup>2</sup>	19,0kg	07503H01R



**+** COMPLETE YOUR F40VAN WITH SIDE AND FRONT PANELS

Blocker / Blocker Pro

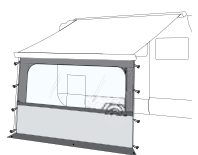

Sun View XL

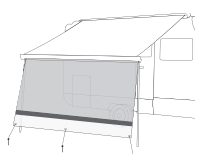

Side W Pro

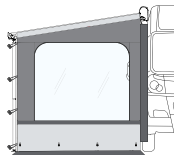

Side Block

new  
20  
24

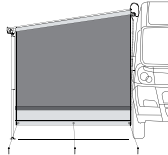

**+** COMPLETE YOUR F40VAN WITH ENCLOSURES

Room Van Premium

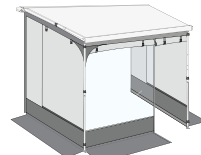

**+** OPTIONAL - RAFTER LED VAN

Rafter for an optimally stretched fabric. It guarantees greater wind resistance and prevents the formation of water pockets in the event of rain, thanks to its installation perpendicular to the arms of the awning. It comes with LEDs to illuminate your holiday space.

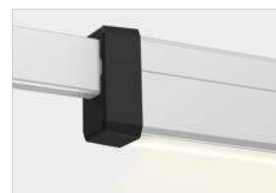



# F35pro

SUITABLE FOR CAMPERVANS



Lightweight but very strong, this aluminium awning with legs and rafters integrated into the roller is ideal if you want to go on an adventure in your minivan.



**FEATURES:**

- Manual opening
- Easy installation on the wall, on roof bars or rail
- Wide range of optional brackets to fit your vehicle
- Possibility of raising the front to make maximum use of the awning height
- Length from 180 to 300



**Compact case box**

The awning is contained in a stylish anodised aluminium case box



**Double guide**

To install a front panel or Privacy and other accessories



**Integrated legs**

Stored in the roller, telescopic and easy to take out



**Reinforced arms**

Easy to adjust, keep the fabric tensioned







**+** COMPLETE YOUR F35PRO WITH SIDE AND FRONT PANELS

Blocker / Blocker Pro

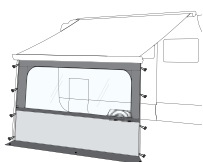

Sun View XL

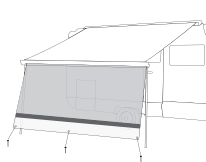

Side W Pro

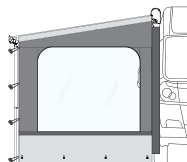

Side W CaravanStore

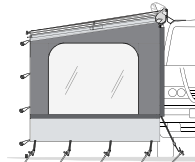

Sun View Side

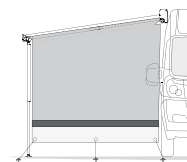

Side Block

new  
2024

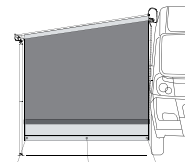

**+** COMPLETE YOUR F35PRO WITH ENCLOSURES

Privacy Room CS Light

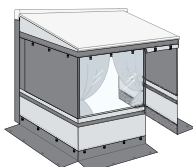

**≡** MODELS AND DIMENSIONS

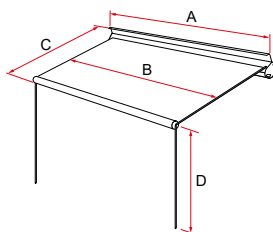
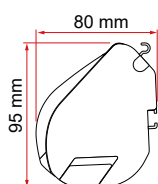

F35pro	Length A	Length B	Extension C	Height from ground D	Shade Surface	Weight	Item No. Titanium	Item No. Deep Black
180	183cm	162cm	180cm	195cm	2,9m <sup>2</sup>	8,5kg	06762-01(X)	06458-01R
220	223cm	202cm			4,5m <sup>2</sup>	10,5kg	06762A01(X)	06458A01R
250	253cm	232cm			5,2m <sup>2</sup>	11,5kg	06762B01(X)	06458B01R
270	273cm	254cm	225cm	225cm	5,7m <sup>2</sup>	13,0kg	06762C01(X)	06458C01R
300	303cm	282cm			6,4m <sup>2</sup>	14,0kg	06762D01(X)	06458D01R

Specify the fabric colour you want when ordering by replacing (X) with: R=Royal Grey, Q=Royal Blue



# Motor Kit

SUITABLE FOR VAN CONVERSIONS AND CAMPERVANS



How to make your awning even more powerful? By installing the right motor for each model! All our motors are 12V powered: ideal for every campsite and vehicle.

**FEATURES:**

- 12V motor
- Equipped with Control System

**TO WHICH AWNINGS DOES IT FIT?**

F45 - F80 (in 3 different variants)

**MODELS**

## MOTOR KIT F45s

Compact motor for F45s awning, characterised by smaller size, simple construction, reliability and excellent performance.

Available in 2 different variants: Compact and Advanced.

**Compact:** equipped with a wall-mounted Control System button for opening and closing the awning.

**Advanced:** allows, via app, management of the awning and control of the LEDs (on/off/dimming); also equipped with Control System wall control.



Motor Kit F45s Advanced

## MOTOR KIT F80s

Small in size and fitted with an aluminium cover, it blends in perfectly with the look of the awning. Available in 2 different variants: Compact, Plus and Advanced.

**Compact:** equipped with a wall-mounted Control System button for opening and closing the awning.

**Plus:** thanks to the convenient infrared remote control and wall control, operating your awning with this motor will be child's play.

**Advanced:** allows, via app, management of the awning and control of the LEDs (on/off/dimming); also equipped with Control System wall control.



Motor Kit F80s Advanced

**CHOOSE THE MODEL THAT SUITS YOU**

	Power supply	Weight	Item No. Polar White	Item No. Titanium	Item No. Deep Black		Weight	Item No.
Motor Kit Compact F80s		1,9kg	07929-01-	07929-01T	07929-01H	Kit Upgrade Advanced F80s*	0,1kg	98655Z111
Motor Kit Plus F80s	12 V	2,0kg	07929-02-	07929-02T	07929-02H			
Motor Kit Advanced F80s		2,0kg	08320-01-	08320-01T	08320-01H			
		Power supply	Weight	Item No. Polar White	Item No. Titanium	Item No. Deep Black		
Motor Kit Compact F45s		12 V	2,0kg	08319-01P	08319-01T	08319-01H		
Motor Kit Advanced F45s			2,1kg	08455-01P	08455-01T	08455-01H		

\* Also available the Kit Upgrade for Motor Kit Plus for conversion into Motor Kit Advanced.

F45s for RHD vehicles (UK) available on request. The Motor Kit is not suitable for Fiamma ZIP awnings.



# Accessories



## TIE DOWN

This kit with anchoring straps optimally fixes wall or roof awnings to the ground. It consists of an 11m adjustable strap, two pegs and a tensioning spring.



## TIE DOWN S

Anchoring kit for easy and solid attachment to the ground from the front of awnings, also designed to be attached to the side of Privacy Room. It consists of 2 adjustable 300cm bands, 2 pegs, 2 tension springs and 2 front hooks. It is also designed to be attached to the Privacy side panel. CaravanStore Tie Down S version suitable for CS and F35pro (with leg attachment).



## PATIO-MAT / PATIO-BAG

Comfortable completion mat for your Privacy. It is made of breathable, self-extinguishing and UV-resistant polypropylene. Also available in a Light version featuring a lighter fabric, without edging and equipped with a standard bag. Patio Bag is optionally available for the Patio Mat.

# Rain Guard and Cover

Various types of seals and covers to improve the integration of the bracket with the vehicle.

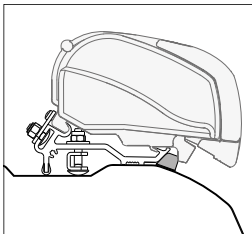

**KIT RAIN GUARD SLIM F80S DUCATO**

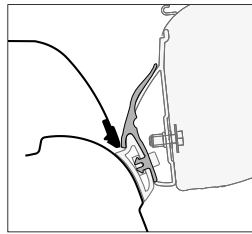

**KIT RAIN GUARD CALIFORNIA**

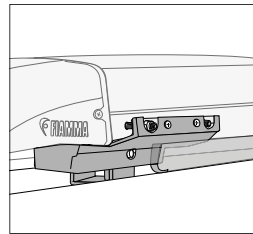

**KIT RAIN GUARD + COVER F40 VAN - VW T5/T6**

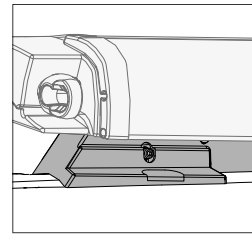

**KIT RAIN GUARD + COVER F40 VAN - FORD CUSTOM**

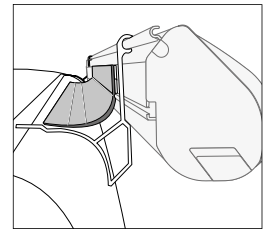

**KIT RAIN GUARD VAN**

# Other accessories

How to make your awning even more effective and performing? Simple: just add one or more dedicated Fiamma accessories. Discover them all!





# Blocker

SUITABLE FOR VAN CONVERSIONS AND CAMPERVANS



The Fiamma front walls allow easy access to the awning's shaded area, giving you greater protection.

**FEATURES:**

- Quick installation
- They are also suitable for awnings of other brands
- Crystal full light window (Blocker Pro)

Sun protection

Rain protection

Wind protection

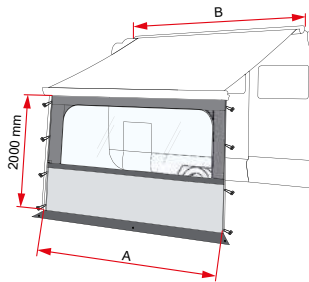

**BLOCKER PRO**

Front panel with a large Crystal full light window, with extension to the ground. Made of rot-proof, washable and easy to assemble vinyl fabric with UV protection. Complete with elastics hooks and pegs for fastening.

Compatible with: F45s, F43van, F80s, F40van, F35pro.  
Panel length: from ± 100cm to ± 513cm.

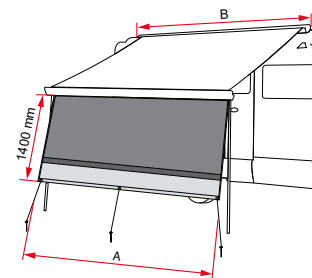

**BLOCKER**

Convenient front panel that protects you from sun light and rain and gives you more privacy. Complete with ropes and pegs for fastening.

Compatible with: F45s, F43van, F80s, F40van, F35pro.  
Panel length: from ± 253cm to ± 438cm.

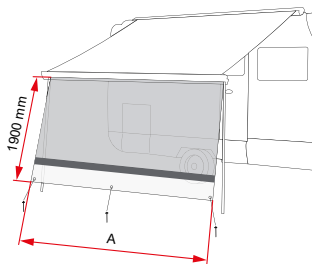

**SUN VIEW XL**

Comfortable front panel. Made of translucent light filtering fabric, which partially blocks out light. It can be rolled up with convenient fixing clips. Supplied with ropes and pegs for fastening.

Compatible with: F45s, F43van, F80s, F40van, F35pro.  
Panel length: from ± 100cm to ± 513cm.

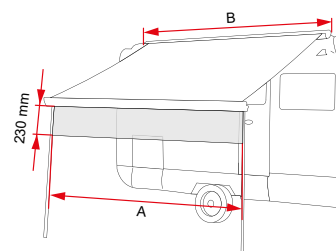

**SHADE SUN VIEW**

The Shade Sun View valance with translucent light filtering material protects from sun and rain extending the shade surface. Suitable for all awning models, single length 600cm easily adjustable to the length of the awning.

Compatible with: F45s, F43van, F80s, F40van, F35pro.

**ACCESSORIES**

**MEGA BAG**

Large, strong bag for storing the front and side panels of the Blocker and Side range or any other accessory you want to protect. Available in two sizes (p. 66).





☰ CHOOSE THE MODEL THAT SUITS YOU

	F45s	F43van	F80s	F40van	F35pro	Length A	Min. awning length B	Weight	Item No.
Blocker Pro 100 *	●		●		●	± 100cm	-	0,8kg	07971-12-
Blocker Pro 250	●				●	± 235cm	250cm	2,7kg	07971-01-
Blocker Pro 260 Van	●	●		●	●	± 250cm	260cm	2,7kg	07971A01-
Blocker Pro 280					●	± 255cm	270cm	3,0kg	07971-02-
Blocker Pro 300	●	●	●		●	± 285cm	300cm	3,2kg	07971-03-
Blocker Pro 325	●		●			± 310cm	325cm	3,4kg	07971-13-
Blocker Pro 350	●		●			± 335cm	340cm	3,8kg	07971-04-
Blocker Pro 375	●		●			± 360cm	370cm	4,1kg	07971-05-
Blocker Pro 400	●		●			± 385cm	400cm	4,5kg	07971-06-
Blocker 260	●	●	●	●	●	± 253cm	250cm	2,3kg	07972-04-
Blocker 300	●	●	●		●	± 285cm	300cm	2,6kg	07972-01-
Blocker 325	●		●			± 310cm	320cm	2,7kg	07972-06-
Blocker 350	●		●			± 335cm	340cm	2,9kg	07972-02-
Blocker 400	●		●			± 385cm	400cm	3,3kg	07972-03-
Sun View XL 100	●	●	●	●	●	± 100cm	-	0,5kg	08184-01-
Sun View XL 260	●	●	●	●	●	± 250cm	250cm	1,9kg	08184-02-
Sun View XL 300	●	●	●		●	± 285cm	300cm	2,1kg	08184-03-
Sun View XL 325	●		●			± 310cm	325cm	2,2kg	08184-11-
Sun View XL 350	●		●			± 335cm	340cm	2,3kg	08184-04-
Sun View XL 375	●		●			± 360cm	370cm	2,4kg	08184-05-
Sun View XL 400	●		●			± 385cm	400cm	2,5kg	08184-06-
Shade Sun View	●	●	●	●	●	± 600cm	190cm	0,5kg	07758-01-

● Suitable for

\* Blocker Pro 100 doesn't have Crystal window





# Side

SUITABLE FOR VAN CONVERSIONS AND CAMPERVANS



Our side panels, which can be installed directly on the awning, give you more privacy while protecting you from wind, rain and sun.

**FEATURES:**

- Quick installation
- They are also suitable for awnings of other brands
- Crystal full light windows (excluding Sun View Side)

Sun protection

Rain protection

Wind protection

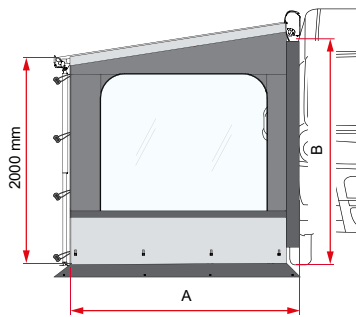

**SIDE W PRO**

Side panel with large Crystal full light window and grey extension to the ground, made of rot-proof, UV-resistant and washable vinyl. Complete with aluminium rafter and pegs.

Compatible with: F45s, F80s, F40van, F35pro  
Extension: from 190cm to 240cm

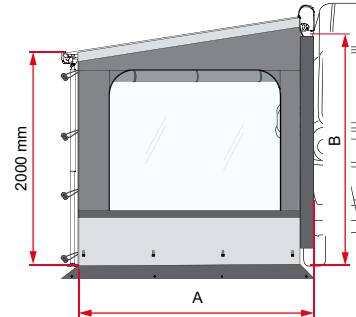

**SIDE W PRO SHADE**

Side enclosure with large Crystal full light window, roller blind and grey extension to the ground, made of rot-proof, UV-resistant and washable vinyl. Complete with aluminium rafter and pegs.

Compatible with: F45s, F80s  
Extension: 230cm

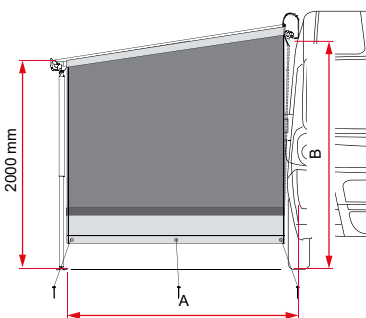

**SIDE BLOCK**

**new**  
**2024**

Vinyl side panel can be combined with Blocker front wall. Washable, rot-proof and UV-resistant. Complete with pegs and elastic bands for fixing.

Compatible with: F45s, F80s  
Extension: 230cm

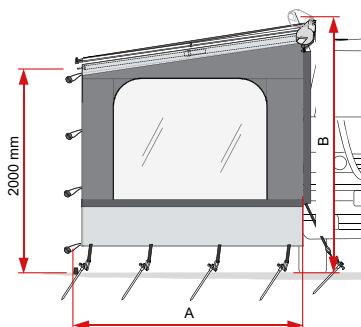

**SIDE W CARAVANSTORE**

Side panel with large Crystal full light window made of rot-proof, UV-resistant and washable vinyl. Complete with aluminium rafter and pegs.

Compatible with: F35pro  
Extension: from 210cm to 240cm

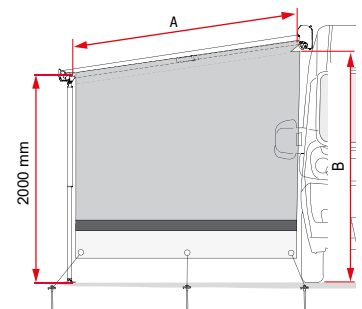

**SUN VIEW SIDE**

Side panel made of translucent light filtering fabric, which partially blocks out light. Complete with aluminium rafter, tension ropes and pegs.

Compatible with: F45s, F80s, F35pro  
Extension: from 210cm to 240cm



☰ CHOOSE THE MODEL THAT SUITS YOU

	F45s	F80s	F40van	F35pro	Length A	Height from ground B	Weight	Item No.
Side W Pro F45 / F80s	●	●			230cm	225-280cm	4,2kg	07973-01-
Side W Pro XXL F45 / F80s	●	●			230cm	280-330cm	4,5kg	07973B01-
Side W Pro Van F45	●				190cm	180-200cm	3,4kg	07973A01-
Side W Pro Ducato F80		●			230cm	245-280cm	4,2kg	07974-01-
Side W Pro F40			●		210cm	180-210cm	3,0kg	07979-01-
Side W Pro CaravanStore / F35				●	210cm	240-260cm	4,5kg	07977-01-
Side W Pro F35 Van				●	210cm	180-220cm	4,2kg	07977A01-
Side W Pro Shade F45 / F80s right	●	●			230cm	225-280cm	5,3kg	07975-01-
Side W Pro Shade F45 / F80s left	●	●			230cm	225-280cm	5,3kg	07976-01-
Side Block F45 / F80 <b>[New]</b>	●	●			230 cm	220 - 260cm	3,3kg	08835-01-
Side W CaravanStore / F35				●	210cm	240-260cm	3,9kg	07978-01-
Sun View Side F45 / F80s	●	●			230cm	220-260cm	1,4kg	08185-01-
Sun View Side CaravanStore / F35				●	210cm	180-260cm	1,3kg	08186-01-
Kit Side F65s / F65L *							0,1kg	98655-073
Kit Side Omnistor 5002 / 5003 *							0,1kg	98655-311
Kit Side Tristor *							0,1kg	98655-079
Kit Side Omnistor 4900 / 5200 - Tristor 2 *							0,1kg	98655-927

● Suitable for

\* The Kit Side allow installation of Side W Pro F45 / F80s, Side W Pro Shade and the Sun View Side F45 / F80s on F65 awnings and on Omnistor 5102/4900 and Tristor/Tristor 2 awnings.

☰ ACCESSORIES

**MEGA BAG**

Large, strong bag for storing the front and side panels of the Blocker and Side range or any other accessory you want to protect. Available in two sizes (p. 66).





# Privacy Room

SUITABLE FOR VAN CONVERSIONS AND CAMPERVANS



FOR FIAMMA WINCH AWNINGS F45s, F80s

Classic enclosure suitable for all seasons, the best solution for medium and long term stays.

**FEATURES:**

- Modularity: base modules (Van [S], Medium [M], Large [L]) and a broad range of additional panels
- Composed of front panels and two side panels
- All Crystal full light windows that can be rolled up, with mosquito net and curtains as standard
- The door can be positioned on the left side of the front panel and easily moved to the right side of the same
- Complete with anchor pegs and Bag (dim. 140x27x40cm) to store Privacy Room and poles

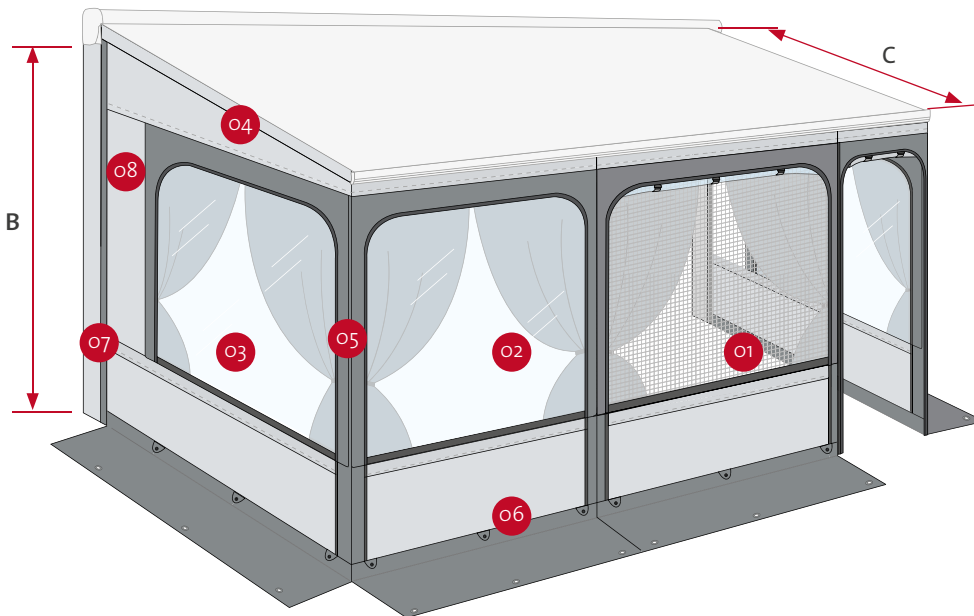

Basic module	Height from ground (B)
F45s (C = 200/250cm)	
[S]	180-220cm
[M]	225-250cm
[L]	251-280cm
Basic module	Height from ground (B)
F80s (C = 250cm)	
[S]	245cm
[M]	245-280cm
[L]	280cm



- 01 Panels**  
With roll-up Crystal full light window, fitted with mosquito net and curtains as standard
- 02 Additional front panels**  
With fixed Crystal full light window and curtains as standard equipment
- 03 Windows**  
Can be closed securely thanks to convenient zips and an extra layer of velcro
- 04 Fast Clip**  
For quick and safe hooking to the awning fabric with internal lever hooks
- 05 Zippers**  
To hermetically join the panels together
- 06 Vinyl fabric**  
Waterproof and UV-resistant, rot-proof and easily washable
- 07 Protective sponge**  
Additional vertical protection for the rear of the side panels
- 08 Vertical Rafter**  
Telescopic aluminium pole as standard (2 pcs), improves grip on the vehicle wall \*

\* F80s version for Ducato complete Magnet Kit, without Vertical Rafter

**CREATE YOUR PRIVACY ROOM**

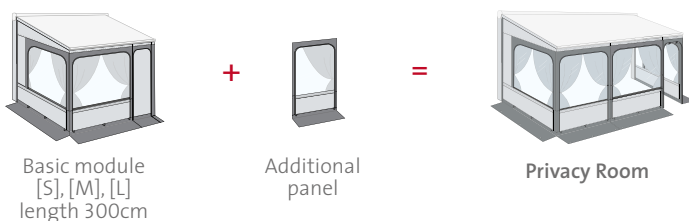

**WHAT YOU CAN ADD TO YOUR PRIVACY ROOM**

Accessories - See page 35



**FOR FIAMMA AWNINGS F45s**

\* B = [S] h 180-220cm / [M] h 225-250cm / [L] h 251-280cm

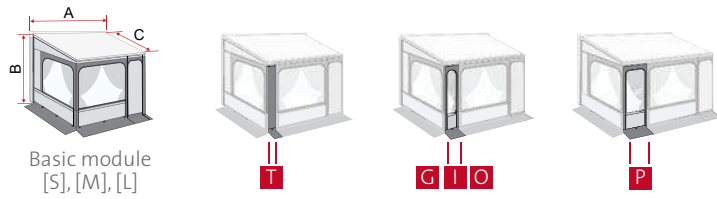

A	C	Basic module *	Weight	Front panels	Item No. Front panels	Weight	
260	200cm	[S] 08366-01-	23,7kg	-	-	-	
300 **				<b>G</b> (40cm)	08367-01-	0,4kg	
300					-	-	-
325	250cm	[M] 08366A01-	24,4kg	<b>T</b> (25cm)	08364N01-	0,3kg	
350				<b>I</b> (50cm)	08364B01-	0,6kg	
375		[L] 08366B01-		24,7kg	<b>O</b> (75cm)	08364D01-	0,7kg
400					<b>P</b> (100cm)	08364E01-	0,9kg

\*\* use with F45s 300 VW awning

**FOR FIAMMA AWNINGS F80s**

\* B = [S] h 180-220cm / [M] h 225-250cm / [L] h 251-280cm



A	C	Basic module *	Weight	Front panels	Item No. Front panels	Weight		
300	250cm	[S] 08760-01-	23,2kg	-	-	-		
320				<b>F</b> (20cm)	08364-01-	0,3kg		
340		[M] 08368B01- **		23,2kg	<b>H</b> (40cm)	08364A01-	0,6kg	
370		[L] 08760A01- ***			24kg	<b>N</b> (70cm)	08364C01-	0,7kg
400						<b>P</b> (100cm)	08364E01-	0,9kg

[S] and [L]: complete with magnet kit (2 sets of 6 magnets) which, inserted in the side panel pocket, permit complete adhesion to the Ducato vehicle.

\*\* This model is suitable for vehicles with straight wall, height from ground 245-280cm.

\*\*\* Designed for Mercedes Sprinter, VW Crafter, Fiat Ducato, Citroën Jumper and Peugeot Boxer - H3, Fast Clip Light aluminium poles delivered as standard.





# Privacy Room Light / CS Light

SUITABLE FOR VAN CONVERSIONS AND CAMPERVANS



FOR FIAMMA WINCH AND MANUAL AWNINGS F45s, F80s AND F35PRO

Aesthetic restyling of the Privacy Room Light and CS Light, featuring new colours and combinations, neutral Crystal, without decorations. Renewed polyester fabric for greater UV resistance; PVC basic module and Crystal windows made of higher-performance materials. Light and compact, suitable for summer or mid-season.

**FEATURES:**

- Modularity: base modules (Van [S], Medium [M], Large [L]) and a broad range of additional panels
- Front panel with roll-up Crystal full light window, fitted with mosquito net and curtains as standard
- Front additional panels with fixed Crystal full light window and standard curtains, or fixed blinds
- Side panels with roll-up blind and mosquito net, roll-up door
- Complete with anchor pegs and Bag Light (dim. 140x25x25cm) to store Privacy Room and poles

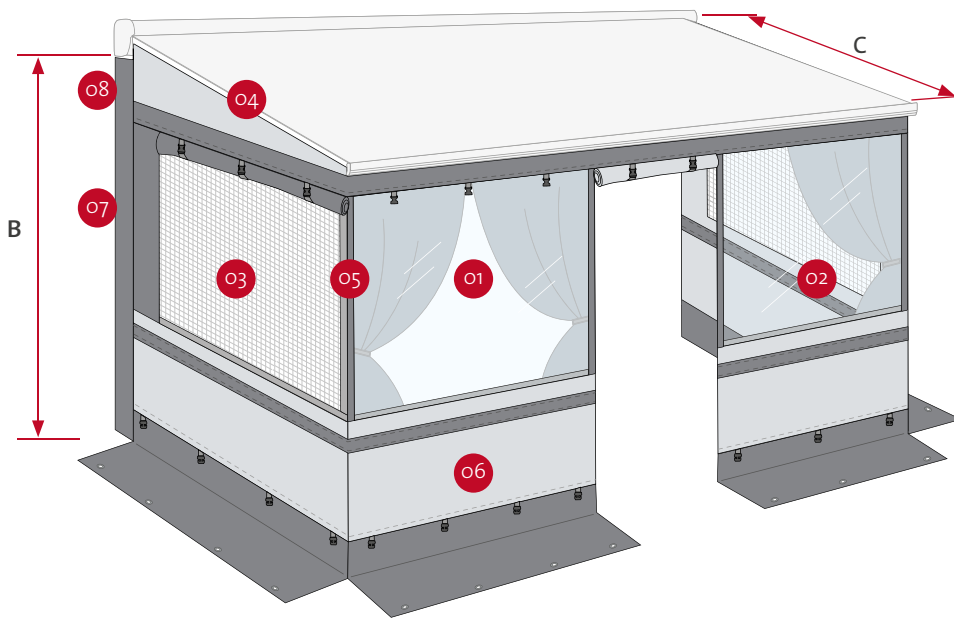

Basic module F45s	Height from ground (B)
[S]	180-220cm
[M]	225-250cm
[L]	251-280cm
Basic module F80s	Height from ground (B)
[S]	245cm
[M]	245-280cm
[L]	280cm
Basic module F35pro	Extension (C)
[D]	225cm



- 01 Front panel**  
With roll-up Crystal full light window, fitted with mosquito net and curtains as standard
- 02 Additional panels**  
With fixed Crystal full light window and standard curtains, or fixed blinds
- 03 Side panels**  
With roll-up blind and mosquito net
- 04 Fast Clip CS**  
For quick and safe hooking to the awning fabric with internal lever hooks
- 05 Zippers**  
To hermetically join the panels together
- 06 Polyester fabric**  
Lightweight, durable and washable
- 07 Kit Poles Light**  
Telescopic aluminium pole as optional (2 pcs), improves grip on the vehicle wall
- 08 Closing elastic**  
Is fixed to the awning and the ground to laterally close the Privacy

**CREATE YOUR PRIVACY ROOM LIGHT / CS LIGHT**

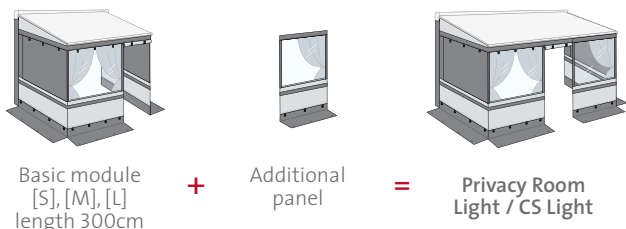

**WHAT YOU CAN ADD TO YOUR PRIVACY ROOM**

Accessories - See page 35



**FOR FIAMMA AWNINGS F45s**

\* B = [S] h 180-220cm / [M] h 225-250cm / [L] h 251-280cm

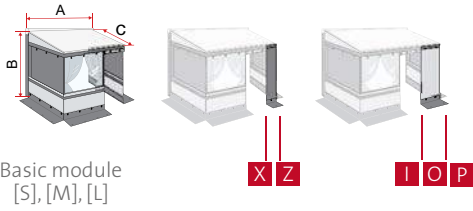

A	C	Basic module *	Weight	Front panels	Item No. Front panels	Weight
260	200cm	[S] 08765-01-	12,0kg	-	-	-
300 van <b>[New]</b>				<b>X</b> (40cm)	08838-01	0,5kg
300	250cm	[M] 08765A01-	14,4kg	-	-	-
325				<b>Z</b> (25cm)	08766A01-	0,4kg
350				<b>I</b> (50cm)	08766B01-	0,6kg
375				<b>O</b> (75cm)	08766C01-	0,7kg
400		[L] 08765B01-	14,7kg	<b>P</b> (100cm)	08766D01-	0,8kg

**FOR FIAMMA AWNINGS F80s**

\* B = [S] h 245cm / [M] h 245-280cm / [L] h 280cm

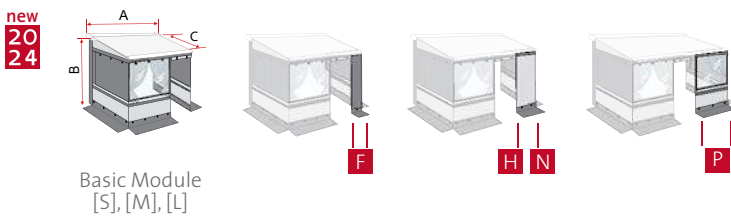

A	C	Basic module *	Weight	Front Panels	Item No.	Weight
300	250cm	Ducato H2 [S] 08837-01- **	14,6kg	-	-	-
320				<b>F</b> (20cm)	08766-01-	0,3kg
340		h 245-280 cm [M] 08837B01- ***	14,8kg	<b>H</b> (40cm)	08766M01-	0,5kg
370		H3 [L]	15,3kg	<b>N</b> (70cm)	08766N01-	0,7kg
400		08837A01- **		<b>P</b> (100 m)	08766D01-	0,8kg

\*\* Complete with magnet kit (2 sets of 6 magnets) which, inserted in the side panel pocket, permit complete adhesion to the Ducato vehicle.

\*\*\* This model is suitable for vehicles with straight wall, height from ground 245-280cm.



**FOR FIAMMA AWNINGS F35PRO**

\* C = [D] 225cm

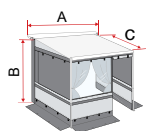

Basic module [D]

A	B	Basic module *	Item No. Basic module	Weight	Suitable for
250		P. R. CS Light 250 Van	08764A01-	8,7kg	F35pro 250
270	180- 220cm	P. R. CS Light 270 Van	08764A02-	9,1kg	F35pro 270
280		P. R. CS Light 280	08764-01-	11,6kg	F35pro 270
310	240-260cm	[D]	08764-02-	11,8kg	F35pro 300

Item No.
Kit Adapter Privacy Room CS Light F35
98655-925







FIAMMASTORE



CARRY-BIKE

COMFORT



# Privacy Ultra Light

SUITABLE FOR VAN CONVERSIONS AND CAMPERVANS



FOR FIAMMA WINCH AWNINGS F45s, F80s

Enclosure consisting of roof, front and side panels. Quick to install, it is ideal for short stays or weekends.

**FEATURES:**

- Double roof consisting of the awning cover and the Privacy roof, which allows a constant passage of air.
- Single front panel complete with door and fixed Crystal full light window. Possibility of making it completely removable
- Side panels with roll-up blind and mosquito net
- The shaded surface can be increased by completely lifting the side panels with Kit Poles (optional)
- Aluminium rafters and pegs for safe anchoring
- Complete with bag for storing privacy and poles: Bag Light for sizes 260-300-350 (dim. 140x25x25cm) and Bag for size 400 (dim. 140x27x40cm)

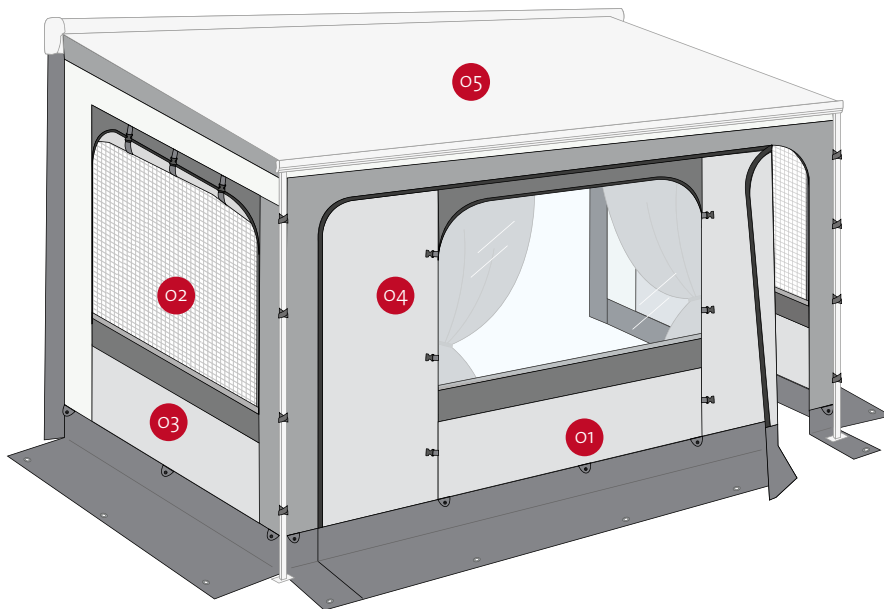

- 01 Front panel**  
Complete with door and fixed Crystal full light window. Possibility of making it completely removable
- 02 One single piece**  
Consisting of roof, side and front panels
- 03 Opening sides**  
Possibility to open them increasing the shaded area with Kit Poles (optional)
- 04 Ripstop polyester fabric**  
Light and tear-resistant
- 05 Double roof**  
Composed of the awning fabric and the Privacy roof which create an air chamber with constant ventilation thus lowering the temperature inside the Privacy

**FOR FIAMMA AWNINGS F45, F80**

**WHAT YOU CAN ADD TO YOUR PRIVACY ULTRA LIGHT**

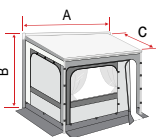

Privacy Ultra Light Van 260 / 300



Privacy Ultra Light 300



Privacy Ultra Light 400

	A	B	C	Weight	Item No.
Privacy Ultra Light Van 260	260cm	180-220cm	200cm	12,3kg	07350A01-
Privacy Ultra Light 300	300cm 320cm			14,2kg	07350-01-
Privacy Ultra Light 350	350cm 370cm	230-280cm	250cm	15,4kg	07350-02-
Privacy Ultra Light 400	400cm			16,6kg	07350-03-

Accessories - See page 35







# Room Van Premium

SUITABLE FOR CAMPERVANS



FOR FIAMMA AWNINGS F40VAN AND F43VAN

Specific enclosure for F40van and F43van.  
Without poles, it is quick to install and ideal for those who like to move on quickly.

**FEATURES:**

- Light and without poles
- Consisting of roof, side and front panels, roll-up door, Crystal full light front panel and roll-up blind, side panels with mosquito nets and roll-up blinds
- Complete with Bag

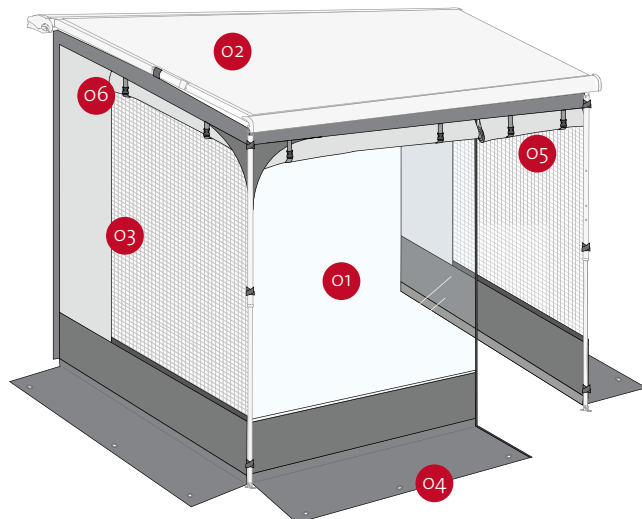

- O1 Room Van Premium**  
Roll-up door, Crystal full light front panel and roll-up blind, side panels with mosquito nets and roll-up blinds
- O2 Ripstop polyester fabric**  
Light and tear-resistant
- O3 Fixing**  
No poles, direct fixing to the case box and the lead bar of the awning
- O4 One single piece**  
Made in one piece consisting of roof, sides and fronts
- O5 Opening front panel**  
Completely openable by increasing the shaded area (with optional Poles Kit)
- O6 Compact**  
Takes up little storage space in the Bag provided

**+** WHAT YOU CAN ADD TO YOUR ROOM VAN PREMIUM

Accessories - See page 35

**☰** FOR THE AWNING FIAMMA F40VAN AND F43VAN

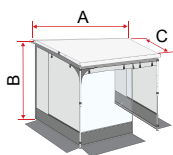

	F40van	F43van	A	B	C	Weight	Item No.
Room Van Premium 270	•	•	270 cm	180-210 cm	225 cm	5,4 kg	08870-01-
Room Van Premium 300 [New]		•	300 cm	180-210 cm	225 cm	5,8 kg	08210-02-

• Suitable for



# Moonlight Tent <sup>new</sup> 2024

SUITABLE FOR CAMPERVANS, 4x4 AND CARS



FOR VEHICLES EQUIPPED WITH ROOF BARS



Roof tent ideal for trips in the great outdoors, designed for minivans, SUVs and any vehicle equipped with roof rails.



## FEATURES:

- Compatible with roof bars approved for >75kg and width >78cm
- Compatible with wall awnings
- 140 version homologated for 2 people, 180 version for 3 people
- Mosquito nets and blackout blinds can be opened on all 4 sides, complete rain cover with windows
- YKK closing hinges
- Equipped with 2.30 m aluminium ladder (max. load 150 kg) and waterproof cover bag
- Interior LED strip with adjustable light intensity

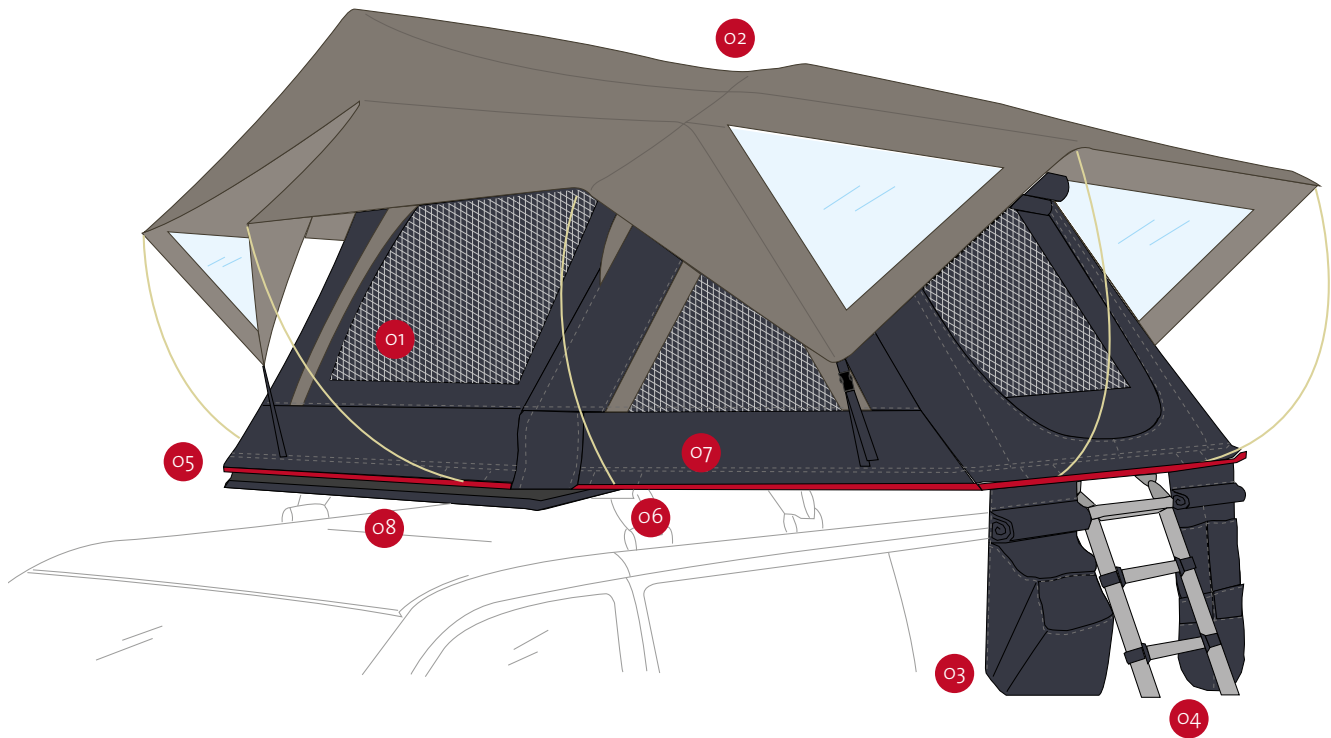

### 01 Openings

Equipped with mosquito nets and blackout blinds on all 4 sides

### 02 Rain cover

With extended canopies for better protection

### 03 Bag

For better storage of your accessories

### 04 Ladder

Aluminium, height 2.3 m

### 05 Fabric

Curtain: 200g/m<sup>2</sup>, Poly-cotton  
Canvas  
Cover: Oxford 210D  
Cover bag: Oxford 700D

### 06 Opening

Folding, quick and easy

### 07 Mattress

5 cm thick consisting of 2 types of foam with different densities

### 08 Floor base

In aluminium honeycomb panels



☰ MODELS AND DIMENSIONS



	Dimensions when open	Dimensions when closed	Internal dimensions	Weight *	Load capacity	No. of persons	Item No.
Moonlight Tent 140	140 x 240 x 120cm	148 x 130 x 27cm	139 x 238 x 120cm	54kg	500kg	2 max	08890-01-
Moonlight Tent 180	180 x 240 x 120cm	184 x 130 x 27cm	179 x 238 x 120cm	62kg	500kg	3 max	08891-01-

\* ladder included

✚ OPTIONAL - PRIVACY MOONLIGHT TENT

Complete your rooftop tent by creating a multi-purpose changing room that will provide more privacy. For campervans and 4x4.

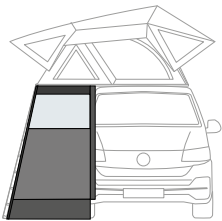

	Height from ground	Weight	Item No.
Privacy Moonlight Tent 140	H=180-220cm	4,7kg	08892-01-
Privacy Moonlight Tent 180		5,0kg	08893-01-







# Rear Door Cover

SUITABLE FOR VAN CONVERSIONS AND CAMPERVANS



Our practical tailgate enclosures for minivans and vans are designed to increase your privacy.

**FEATURES:**

- Quick installation
- To make the most of the space

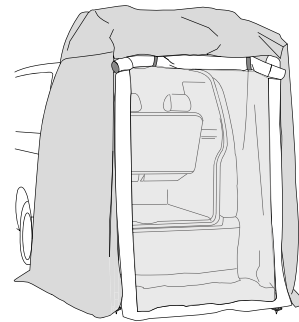
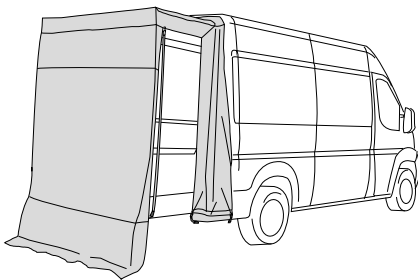

## REAR DOOR COVER DUCATO

Enclosure with side bands and a front folding closure. Suitable for Fiat Ducato, Citroën Jumper and Peugeot Boxer H2 after 2006 and Mercedes Sprinter H2 from 2006 to 2008. Complete with awning rafter, pegs and tensioning elastics.

## REAR DOOR COVER VW T5 / T6

Can be quickly installed on standard tailgates also with mounted bike rack (without bikes). It is an enclosure with a roll-up or extendable door and mosquito net. Complete with floor poles, pegs, tension elastics and Bag Light.

**CHOOSE THE MODEL THAT SUITS YOU**

	Weight	Item No.
Rear Door Cover Ducato	3,3kg	06357-01-
Rear Door Cover VW T5 / T6	9,8kg	06539-01-
Kit Poles	0,7kg	06537-01-

**ACCESSORIES**

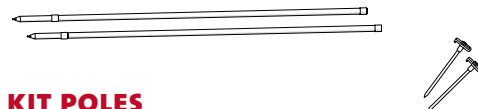

### KIT POLES

Set of two aluminium poles to extend the door as an additional awning.







# Skirting

SUITABLE FOR VAN CONVERSIONS AND CAMPERVANS



You can say goodbye to those annoying draughts coming from the underside of your vehicle.

**FEATURES:**

- Can be shortened to awning size
- Different models for each type of vehicle

## SKIRTING VW T5 / T6

The perfect model for Volkswagen campervans, it comes complete with wheel cover, elastic belts and magnets for attachment.



## SKIRTING DUCATO

Complete with wheel cover, elastic belts and magnets for attachment, it is suitable for wheelbases of lengths L2, L3 and L4.



## REAR SKIRTING VW T5 / T6

Attach the wind protector to the back of your vehicle. Perfect in combination with Rear Door Cover VW T5 / T6.



## REAR SKIRTING DUCATO

Attach the wind protector to the back of your vehicle. Perfect in combination with Rear Door Cover Ducato.



**☰ CHOOSE THE MODEL THAT SUITS YOU**

	Dimensions	Weight	Item No.		Weight	Item No.
Skirting Ducato	497x45h cm	1,4kg	98655-405	Rear Skirting VW T5 / T6	1,1kg	06538-01-
Skirting VW T5 / T6	250x42h cm	0,7kg	98655-387	Rear Skirting Ducato	1,7kg	06469-01-

# Accessories

Accessories



Other accessories for enclosure



Complete your enclosure with the right accessories to create a true open-air room.







## **CARRY-BIKE**

The freedom to go wherever we want, without constraints, is the value that inspires all Fiamma products. We manufacture our bike carriers - 100% made in Italy - with high-quality and extremely durable materials, to ensure maximum safety in transport and the best performance over time, not forgetting protection and care for your bikes.

Take your bike, load it on your Fiamma Carry-Bike and leave for your next adventure!

# **Your bike, companion of travel.**



# VW T5 / T6 PRO

SUITABLE FOR CAMPERVANS



FROM 2 TO 4 BIKES / 2 E-BIKE

Specific for VW T5 and T6, easy mounting and installation.

## FEATURES:

- You can open the tailgate with the Carry-Bike mounted without bikes
- Shaped rail support: third stop lamp always visible with bike carrier closed
- Solid anchorage to reinforced points of tailgate
- Suitable for vehicles with raised roof too
- T5 version without plastic top covers

## MODELS



### Upper brackets T6 Pro

Shaped to optimally follow the line of the vehicle



### Lower brackets

They ensure attachment to the vehicle and fit the line of the tailgate

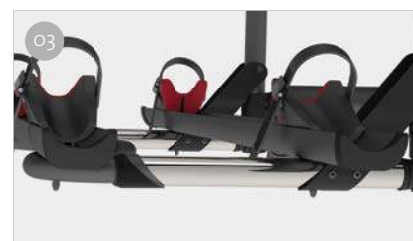

### Telescopic rail support

To fit up to 4 bikes

## + WHAT YOU CAN ADD TO YOUR CARRY-BIKE

Bike-Block - See page 53

Rail - See page 51

Accessories - See page 52



☰ CHOOSE THE MODEL THAT SUITS YOU

	VW T5 Pro Deep Black	VW T6 Pro Deep Black**
Item No.	02096-71A	02094C08A
Weight / Max load	13,0kg / 60,0kg	13,0kg / 60,0kg
Bikes	2 / 4 max 2 E-Bike	2 / 4 max 2 E-Bike
Rail type / Bike-Block	Rail Premium Pro S1 / Pro S3	Rail Premium Pro S1 / Pro S3
Dimensions *	128 x 67 x 85cm	128 x 67 x 85cm
Distance between rails	15cm	15cm
Vehicle compatibility	VW T5 Transporter / Caravelle / Multivan / California (≥ 2003 ≤ 2014)	VW T6 Transporter / Caravelle / Multivan / California (≥ 2014)

\* with rail support base in standard open position and in models with minimum adjustable vertical wheelbase  
 \*\* T6 Pro version compatible with T6.1

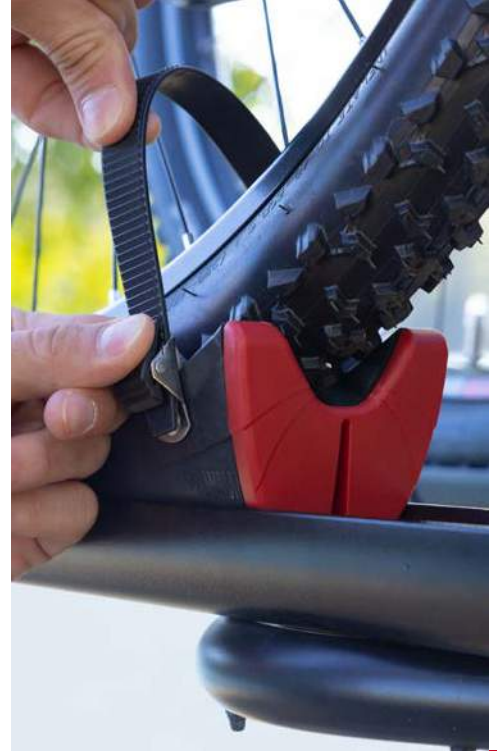

FIAMMASTORE



CARRY-BIKE



COMFORT

# Campervan VW

SUITABLE FOR CAMPERVANS



FROM 2 TO 4 BIKES / 2 E-BIKE

For all Volkswagen campervan models, Fiamma has designed the perfect Carry-Bike. From Caddy to T2.

## FEATURES:

- All models allow the tailgate to be opened with the bike carrier mounted without bikes
- Telescopic rail support base made of stainless steel AISI 304 and aluminium 6060 for models that carry up to 4 bikes
- Aluminium 6060 rail support base for models that carry 2 bikes
- Available Deep Black version for VW T5 / T6 D

## MODELS

E-Bike 



**VW CADDY**

E-Bike 



**VW T5 / T6**



**VW T5 / T6 D**



**VW T4**



**VW T4 D**



**VW T3 (T25)**



**VW T2**



**Upper brackets**  
Designed to follow the shape of the vehicle



**Rail Quick Pro**  
For quick and secure locking of the wheel to the rail



**Rail Plus**  
For increased torsion and flexural strength

## WHAT YOU CAN ADD TO YOUR CARRY-BIKE

Bike-Block - See page 53

Rail - See page 51

Accessories - See page 52



 CHOOSE THE MODEL THAT SUITS YOU

	VW Caddy	VW T5	VW T6	VW T5 D / T6 D VW T5 D / T6 D Deep Black
Item No.	02096-24-	02096-17-	02096-20-	02096-79- / 02096-79A
Weight / Max load	11,7kg / 60kg	9,1kg / 60kg	9,2kg / 60kg	7,1kg / 35kg
Bikes	2 / 4 max 2 E-Bike	2 / 4 max 2 E-Bike	2 / 4 max 2 E-Bike	2
Rail type / Bike-Block	Rail Plus Pro S 1 / Pro S 3	Rail Plus Pro S 1 / Pro S 3	Rail Plus Pro S 1 / Pro S 3	Rail Plus Pro S 1 / Pro S 2
Dimensions *	138 x 59 x 113cm	128 x 56 x 145cm	128 x 56 x 142cm	128 x 46,5 x 144cm
Vehicle compatibility	VW Caddy / Caddy Maxi ≥ 2016 ≤ 2020	VW T5 Transporter / Caravelle / Multivan / California (≥ 2003 ≤ 2014)	VW T6 Transporter / Caravelle / Multivan / California (≥ 2014)	Versions for double rear door VW T5 (≥ 2003 ≤ 2014) and T6 (≥ 2014) Transporter / Caravelle / Multivan

\* with rail support base in standard open position and in models with minimum adjustable vertical wheelbase

VW Caddy



VW T5



VW T6



VW T5/T6 D



	VW T4	VW T4 D	VW T3 (T25)	VW T2
Item No.	02094-18A	02096-22-	02094-19A	02093B63A
Weight / Max load	8,3kg / 60,0kg	7,9kg / 35,0kg	6,5kg / 50,0kg	7,0kg / 35,0kg
Bikes	2 / 4 max	2	2 / 3 max	2
Rail type / Bike-Block	Rail Quick Pro Pro S 1 / Pro S 3	Rail Plus Pro S 1 / Pro S 2	Rail Quick Pro Pro S 1 / Pro S 3	Rail Quick Pro Pro S 1 / Pro S 2
Dimensions *	128 x 54 x 138cm	128 x 42,5 x 138,5cm	128 x 68 x 94,5cm	128 x 63 x 76cm
Vehicle compatibility	T4 (≥ 1990 ≤ 2003) also for models with lift roof	Versions for double rear door. T4 (≥ 1990 ≤ 2003)	T3 (≥ 1979 ≤ 1990) also for models with lift roof	T2 (≥ 1967 ≤ 1979) T2 Westfalia

\* with rail support base in standard open position and in models with minimum adjustable vertical wheelbase

VW T4



VW T4 D



VW T3(T25)



VW T2



# Mercedes Campervan

SUITABLE FOR CAMPERVANS



FROM 2 TO 4 BIKES / 2 E-BIKE



The ideal bike carriers for the Mercedes campervan range, they can carry two bicycles.

## FEATURES:

- All models allow the tailgate to be opened with the bike carrier mounted without bikes
- Mercedes V Class Lift E-Bike: equipped with dropping support rail

## MODELS

E-Bike

**VITO****VIANO**

E-Bike

**V CLASS PREMIUM**

E-Bike

**V CLASS LIFT E-BIKE**

## CHOOSE THE MODEL THAT SUITS YOU

	Mercedes Viano	Mercedes Vito	Mercedes V Class Premium *	Mercedes V Class Lift E-Bike
Item No.	02093B75A	02096-02-	02096-14-	02095A15A
Weight / Max load	10,0kg / 50,0kg	9,2kg / 60,0kg	18,3kg / 60,0kg	20,5kg / 60,0kg
Bikes	2 / 3 max	2 / 4 max 2 E-Bike	2 / 4 max 2 E-Bike	2 E-Bike
Rail type / Bike-Block	Rail Quick Pro Pro S 1 / Pro S 3	Rail Plus Pro S 1 / Pro S 3	Rail Plus Pro S 1 / Pro S 3	Rail Premium Pro S 1 / Pro S 3
Dimensions **	148 x 60 x 110cm	128 x 54,5 x 138cm	154 x 60 x 95cm	153 x 86 x 123cm
Vehicle compatibility	Mercedes Viano II series, Vito II series and Marco Polo II series with single rear door (≥ 2003 ≤ 2013)	Mercedes Viano Vito I series and Marco Polo I series with single rear door (≥ 1996 ≤ 2003)	Mercedes V Class III series, Vito III series and Marco Polo III series with a single tailgate (≥ 2014)	Mercedes V Class III series, Vito III series and Marco Polo III series with a single tailgate (≥ 2014)

\* This version allows the installation of the rail support base in two different positions, one standard and one lower to make it easier to load the bikes. Lower version must be used with the License Plate Carrier, which has the license plate holder bar and regulation lights.

\*\* with rail support base in standard open position and in models with minimum adjustable vertical wheelbase

## SAFE MOUNTING

In the Viano and Mercedes V Class versions, the upper structure of the bike carrier is screwed to the vehicle chassis through the holes provided by the parent company, avoiding any problems of incorrect positioning during installation.



## WHAT YOU CAN ADD TO YOUR CARRY-BIKE

Bike-Block - See page 53

Rail - See page 51

Accessories - See page 52







# Campervans

SUITABLE FOR CAMPERVANS



FROM 2 TO 4 BIKES / 2 E-BIKE

Whatever your campervan, Fiamma has the solution for you.

## FEATURES:

- Version dedicated to PSA group camper vans
- All models allow the tailgate to be opened with the bike carrier mounted without bikes
- Telescopic rail support base made of stainless steel AISI 304 and aluminium 6060 for models that carry up to 4 bikes
- Aluminium 6060 rail support base for models that carry 2 bikes



Ford Custom Nugget



Ford Custom



PSA



## MODELS

E-Bike

**VIVARO - TRAFIC - TALENTO**

E-Bike

**VIVARO - TRAFIC - TALENTO D****FORD TRANSIT**

E-Bike

**FORD CUSTOM NUGGET / NUGGET PLUS HIGHROOF**

E-Bike

**FORD CUSTOM**

E-Bike

**PSA**

**Upper brackets**  
Designed to follow the shape of the vehicle



**Stabilisation system**  
To increase the safety of your bike carrier



**Curved bottom fixing-bar**  
For greater adhesion to the tailgate

## WHAT YOU CAN ADD TO YOUR CARRY-BIKE

Bike-Block

- See page 53

Rail

- See page 51

Accessories

- See page 52



### CHOOSE THE MODEL THAT SUITS YOU

	Vivaro - Traffic - Talento	Vivaro - Traffic - Talento D*	Ford Transit
Item No.	02096-72-	02096-74-	02093A60A
Weight / Max load	9,1kg / 60,0kg	7,3kg / 50,0kg	7,1kg / 50,0kg
Bikes	2 / 4 max 2 E-Bike	2 2 E-Bike	2 / 3 max
Rail type / Bike-Block	Rail Plus Pro S 1 / Pro S 3	Rail Plus Pro S 1 / Pro S 3	Rail Quick Pro Pro S 1 / Pro S 3
Dimensions **	128 x 53 x 143cm	128 x 51 x 144cm	128 x 53 x 150cm
Vehicle compatibility	Renault Traffic II series / Opel Vivaro A / Vauxhall Vivaro A / Nissan Primastar I-II series (≥ 2001 ≤ 2014 - H1) Renault Traffic III series / Nissan NV300 / Fiat Talento (≥ 2014 - H1) Opel Vivaro B / Vauxhall Vivaro B (≥ 2014 ≤ 2018 - H1)	Renault Traffic II series / Opel Vivaro A / Vauxhall Vivaro A / Nissan Primastar I-II series (≥ 2001 ≤ 2014 - H1) Renault Traffic III series / Nissan NV300 / Fiat Talento (≥ 2014 - H1) Opel Vivaro B / Vauxhall Vivaro B (≥ 2014 ≤ 2018 - H1)	Ford Transit MK3-MK4-MK5-MK6-MK7 (≥ 2000 ≤ 2011 - H1)

\* version for vehicles with double rear doors

\*\* with rail support base in standard open position and in models with minimum adjustable vertical wheelbase

	Ford Transit Custom Nugget / Nugget Plus (Highroof) Deep Black	Ford Custom Deep Black	PSA / Deep Black
Item No.	02096-07A	02096-06A	02096-28- / 02096-28A
Weight / Max load	8,4kg / 50,0kg	8,6kg / 50,0kg	11,3kg / 60,0kg
Bikes	2 / 3 max 2 E-Bike	2 / 3 max 2 E-Bike	2 / 4 max 2 E-Bike
Rail type / Bike-Block	Rail Plus Pro S 1 / Pro S 3	Rail Plus Pro S 1 / Pro S 3	Rail Plus Pro S 1 / Pro S 3
Dimensions *	156 x 60 x 80cm	156 x 60 x 88cm	145,8 x 62,5 x 114cm
Vehicle compatibility	Ford Transit Custom Nugget / Nugget Plus (≥ 2012) raised roof (highroof)	Ford Transit / Tourneo Custom single tailgate (≥ 2012 - H1) also for models with lift roof	Citroën Jumpy III gen. - Spacetourer ≥ 2016 - H1 Opel / Vauxhall Vivaro C - Zafira Life 2019 - Vivaro Life ≥ 2019 - H1 Peugeot Expert III gen. - Traveller ≥ 2016 - H1 Toyota ProAce II - ProAce Verso ≥ 2016 - H1 Also for models with lift roof

\* with rail support base in standard open position and in models with minimum adjustable vertical wheelbase





# Frame

SUITABLE FOR VAN CONVERSIONS



FROM 2 TO 3 BIKES / 2 E-BIKE

One bike carrier and 3 different dedicated frames for each type of vehicle (Ducato, Sprinter and Crafter), which can be purchased separately.

**FEATURES:**

- Stainless steel AISI 304 rail support base
- The geometric configuration of the Carry-Bike allows the rear door of the vehicle to be opened even with the bikes mounted
- Deluxe ladder can be mounted on the left hand door
- Not suitable for vehicles with 270° hinge system
- Mounting of the rail support in 3 positions: standard, middle and low, for the last two, the license plate bar with lights must be used

**COMPOSITION**

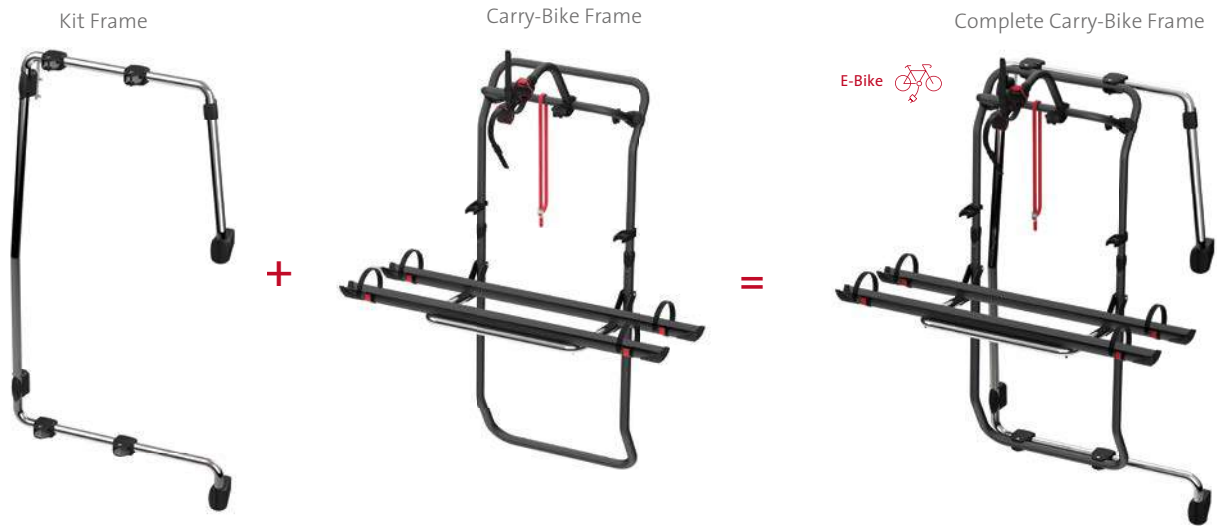

**MODULARITY**

Kit Frame	Item No.		Carry-Bike	Item No. Deep Black / Alu		Complete Carry-Bike
Kit Frame Ducato	08753-01-					Carry- Bike Frame Ducato
Kit Frame Sprinter	08753-02-	+	Carry-Bike Frame	02096-35A / 02096-35-	=	Carry- Bike Frame Sprinter
Kit Frame Crafter	08753-03-					Carry- Bike Frame Crafter

**MODELS**



**FRAME DUCATO**



**FRAME SPRINTER**



**FRAME CRAFTER**



**CHOOSE THE MODEL THAT SUITS YOU**

	Kit Frame Ducato	Kit Frame Sprinter	Kit Frame Crafter	Carry-Bike Frame / Deep Black
Item No. Deep Black / Alu	08753-01-	08753-02-	08753-03-	02096-35A / 02096-35-
Weight / Max load	10,8kg	9,5kg	9,5kg	9,4kg / 50kg
Bikes	-	-	-	2 / 3 max 2 E-Bike
Rail type / Bike-Block	-	-	-	Rail Plus Pro S1 / Pro S3
Dimensions	96 x 136cm	133 x 168cm	133 x 168cm	128 x 60cm
Vehicle compatibility	Fiat Ducato III-IV series / Citroen Jumper II-III series / Peugeot Boxer II-III series (≥ 2006 - H2/H3) Not suitable for vehicles with 270° hinge system	Mercedes Sprinter ≥ 2018 - high roof and super high roof Not suitable for vehicles with 270° hinge system	VW Crafter II series / MAN TGE (≥ 2017 - H3 / H4) Not suitable for vehicles with 270° hinge system	-

\* with rail support base in standard open position and in models with minimum adjustable vertical wheelbase

**WHAT YOU CAN ADD TO YOUR CARRY-BIKE**

Bike-Block - See page 53

Rail - See page 51

Accessories - See page 52





# DJ Series

SUITABLE FOR VAN CONVERSIONS



FOR 2 BIKES

One bike carrier for all models and dedicated fixing bars for each type of vehicle (Ducato, Sprinter, Crafter and Transit) that can be purchased separately.

**FEATURES:**

- Aluminium 6060 rail support base
- Deluxe ladder can be mounted on the left hand door
- Anodised aluminium version also available
- Mounting of the rail support in 3 positions: standard, middle and low, for the last two, the license plate bar with lights must be used

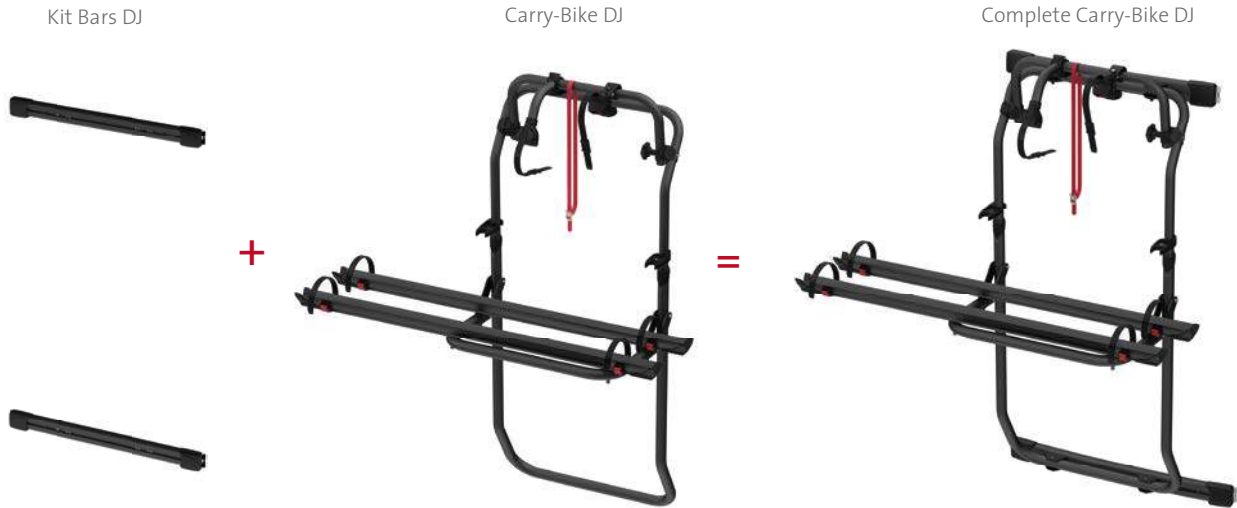
**COMPOSITION****MODULARITY**

Kit Bars	Item No. Deep Black / Alu	Carry-Bike	Item No. Deep Black / Alu	Complete Carry-Bike
Kit Bars DJ Ducato ≥ 06	08754-01A / 08754-01-	+ Carry-Bike DJ	02096-26A / 02096-26-	Carry- Bike DJ Ducato
Kit Bars DJ Sprinter ≥ 06 / Crafter ≥ 06 ≤ 16	08754-02A / 08754-02-			Carry- Bike DJ Sprinter / Crafter
Kit Bars DJ Crafter ≥ 17	08754-03A / 08754-03-			Carry- Bike DJ Crafter
Kit Bars DJ Transit ≥ 14	08754-04A / 08754-04-			Carry- Bike DJ Transit

**+ WHAT YOU CAN ADD TO YOUR CARRY-BIKE**

Bike-Block

- See page 53

Rail

- See page 51

Accessories

- See page 52



 CHOOSE THE MODEL THAT SUITS YOU

	Kit Bars DJ Ducato ≥ 06	Kit Bars DJ Sprinter ≥ 06 / Crafter ≥ 06 ≤ 16	Kit Bars DJ Crafter ≥ 17	Kit Bars DJ Transit ≥ 14	Carry-Bike DJ
Item No. Deep Black / Alu	08754-01A / 08754-01-	08754-02A / 08754-02-	08754-03A / 08754-03-	08754-04A / 08754-04-	02096-26A / 02096-26-
Weight / Max load	2,8kg	2,6kg	2,6kg	2,6kg	7,8kg / 35kg
Bikes	-	-	-	-	2 max
Rail type / Bike-Block	-	-	-	-	Rail Quick Pro Pro S 1 / Pro S 3
Dimensions *	130cm	138cm	138cm	H2 120cm / H3 129cm	128 X 55cm
Vehicle compatibility	Fiat Ducato III-IV series / Citroën Jumper II-III series / Peugeot Boxer II-III series (≥ 2006 - H2/H3)	Mercedes Sprinter II series / Freightliner Sprinter / Dodge Sprinter (≥ 2006 ≤ 2018 - H2) Mercedes Sprinter III series / Freightliner Sprinter / Dodge Sprinter (≥ 2018 - H2) VW Crafter I gen. (≥ 2006 ≤ 2016 - H2)	VW Crafter II series / MAN TGE (≥ 2017 - H3 / H4)	Ford Transit (≥ 2014 - H2 / H3)	-

\* with rail support base in standard open position and in models with minimum adjustable vertical wheelbase



# Van conversions

SUITABLE FOR VAN CONVERSIONS



FOR 2 BIKES



These bike carriers are installed on the right-hand door of the vehicle, leaving the left-hand door free for the possible installation of a Deluxe ladder to access the roof of the vehicle.

## FEATURES:

- Installation with Fixing Bar for 200 DJ Ducato
- Solid and light aluminium 6060 structure
- Rear door opens even with bikes mounted

## MODELS



**200 DJ DUCATO < 2006**



**200 D**

## CHOOSE THE MODEL THAT SUITS YOU

	200 DJ Ducato < 2006	200 D
Item No.	02093A65A	02096-16-
Weight / Max load	9,0kg / 35kg	6,9kg / 35kg
Bikes	2 max	2 max
Rail type / Bike-Block	Rail Premium	Rail Quick Pro
	ProS 1 / Pro S 2	Pro S 1 / Pro S 2
Dimensions *	128 x 43 x 120cm	128 x 48 x 90cm
Distance between rails	15cm	15cm
Vehicle compatibility	Fiat Ducato II series/ Citroën Jumper I series/ Peugeot Boxer I series (≥ 2000 ≤ 2006 - H2) Mercedes Sprinter I series / Mercedes Benz T1N (≥ 1995 ≤ 2006 - H2)	Fiat Ducato I series / Citroën C25 / Peugeot J5 (≥ 1981 ≤ 1994 - H1/H2) Fiat Ducato II series/ Peugeot Boxer I series/ Citroën Jumper I series (≥ 1994 ≤ 1999 - H2) Ford Transit MK3-MK4-MK5-MK6-MK7 (≥ 1987 ≤ 2014 - H1/H2/H3) Ford Transit MK8 (≥ 2014 - H3)

\* with rail support base in standard open position and in models with minimum adjustable vertical wheelbase

## WHAT YOU CAN ADD TO YOUR CARRY-BIKE

Bike-Block - See page 53

Rail - See page 51

Accessories - See page 52





# Rail

SUITABLE FOR VAN CONVERSIONS AND CAMPERVANS, 4x4, AND SUV



Choose the fitting rail model that best suits your bike and your needs: they fit all Carry-Bike models!



## RAIL PLUS / RAIL PLUS XL

New Rail Plus, technically better performing, higher resistance against torsion and bending due to its new geometry and improved material distribution. Larger section for transporting different types of bicycles. Standard version 128cm long, XL version 139cm.



## RAIL QUICK PRO

Sturdy rail with reinforced base delivered with Quick-Safe straps. It is interchangeable with the previous Rail Quick version.



## RAIL PREMIUM / PREMIUM XL

Rail with increased structure size, with sliding bike-lock support, for quicker and more practical fixing. The XL version is 139cm longer and is suited for particularly long E-Bikes and bikes with wheelbase greater than 125cm.



## RAIL PREMIUM S

Rail with increased structure size sliding on the Carry-Bike rail support, it can move in both direction and has adjustable centre-to-centre distance.



## RAIL PREMIUM S FAT BIKE

Model based on Premium S rail for transporting modern Fat Bikes with tyres up to 4,8" wide. Comfortable 40cm strap with fast and safe ratchet coupling.



## KIT RAIL PREMIUM 48

Optional fourth two-part rail for the Carry-Bike VW T5 Pro and T6 Pro models.



## KIT PREMIUM S

Turn Quick and Premium rails into Premium S rails. Quick installation by removing the standard hooks. Now rails can slide horizontally, to be adapted to the dimensions of the different bikes.



 CHOOSE THE MODEL THAT SUITS YOU

	Colour	Weight	Length	Item No.
Rail Plus	Anodised / Deep Black	1,0 kg	128cm	98656M566 / 98656M567
Rail Plus XL	Anodised / Deep Black	1,1 kg	138cm	98656M588 / 98656M589
Rail Quick Pro	Anodised / Deep Black	1,0 kg	128cm	98656-993 / 98656M358
Rail Premium	Anodised / Deep Black	1,3 kg	128cm	98656M131 / 98656M150
Rail Premium XL	Anodised / Deep Black	1,9 kg	139cm	98656M132 / 98656M153
Rail Premium S	Anodised / Deep Black	1,7 kg	128cm	98656M133 / 98656M152
Rail Premium S Fat Bike	Anodised / Deep Black	2,0 kg	128cm	98656M146 / 98656M151
Kit Rail Premium 48	Anodised / Deep Black	1,2 kg	47,5cm	98656M087 / 98656M147
Kit Premium S	Anodised	0,3 kg	-	98656M134
Kit Upgrade E-Bike*	Anodised	5,5 kg	128cm	98656M137

\* Only for Carry-Bike &lt; 2023

 RAILS

Rail Plus



Rail Quick Pro



Rail Premium



## Accessories

Accessories







# Bike-Block Pro S

SUITABLE FOR VAN CONVERSIONS, CAMPERVANS, 4x4 AND SUV



Upgrade of the Fiamma system to secure your bike to the Carry-Bike during transport. Thanks to the adjustable joint, it adapts to all types of bicycles. It is equipped with a secure holding device with clamp, scratch-proof rubber insert and anti-theft safety loop.

**FEATURES:**

- Improved ergonomics thanks to frontally- positioned knob
- Integrated scratch-proof support base with rubber protection for integrated bike hooking
- In D versions, the practical central joint makes hooking the bikes even simpler
- Aluminium tube curved to make it easier to attach the bike



Bike Block Pro S



Bike Block Pro S D

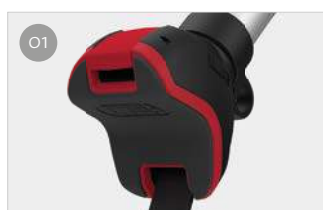

**Bike support base**  
For round or oval tubes  
Ø 25 - 100mm



**Safety buttonhole**  
To use an anti-theft cable when  
fixing the bikes



**360° rotation**  
The clamp and bicycle locking  
system can rotate 360°



**Locking clamp**  
For Ø 30 - 35mm pipes

**CHOOSE THE MODEL THAT SUITS YOU**

	Colour	Weight	Item No.
Bike-Block Pro S 1 <b>[Restyling]</b>		0,2kg	08831-01-/ 08831-01A
Bike-Block Pro S 2 <b>[Restyling]</b>	Anodised / Deep Black	0,3kg	08831A01-/ 08831A01A
Bike-Block Pro S 3 <b>[Restyling]</b>		0,4kg	08831B01-/ 08831B01A
Bike-Block Pro S 4 <b>[Restyling]</b>		0,5kg	08831C01-/ 08831C01A

	Colour	Weight	Item No.
Bike-Block Pro S D1 <b>[Restyling]</b>		0,6kg	08831D01- / 08831D01A
Bike-Block Pro S D2 <b>[Restyling]</b>	Anodised / Deep Black	0,7kg	08831E01- / 08831E01A
Bike-Block Pro S D3 <b>[Restyling]</b>		0,8kg	08831F01- / 08831F01A

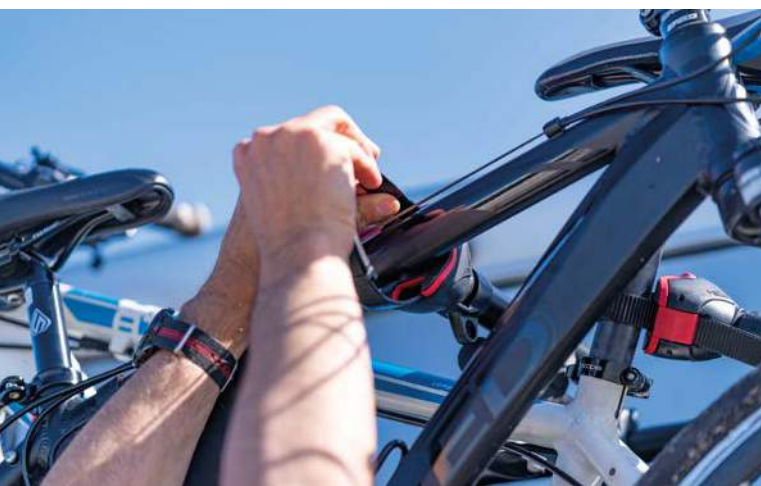

## **COMFORT**

To make you feel at home in every stop and move, Fiamma has created a complete range of devices and accessories that will equip your vehicle with every comfort. Aesthetically appealing and functional in every condition, the right accessories to make your journey more comfortable.

Each solution is designed to occupy as little space as possible while giving you maximum performance.

# Comfort throughout the journey





# Vent 28 F

SUITABLE FOR VAN CONVERSIONS AND CAMPERVANS



A small rooflight, it is suitable for smaller rooms and provides excellent interior lighting. It can be motorised with the Turbo-Vent 28F kit.



## COVER FINISH



## CHOOSE THE MODEL THAT SUITS YOU

	Cover	Weight	Dimensions	Outside dimensions	Internal dimensions	Inside light	Item No.
Vent 28 F	White / Crystal	1,8kg	28x28cm	32x34x9cm	31x34x3cm	25x25cm	07902-02- / 07902-02D

## WHAT YOU CAN ADD TO YOUR VENT 28 F

### KIT TURBO-VENT 28 F

Optional kit to motorise your Vent 28 F. The kit can be added at any time after purchase.

	Kit Turbo Vent 28 F
Item No.	07903-02-
Weight	0,5kg



# Kit Frame Ducato

SUITABLE FOR VAN CONVERSIONS



Kit Frame Ducato



Specially designed interface to allow the Vent 28 F, Vent 40 and Turbo-Vent rooflights to be installed on Ducato, adapting them to the surface of the vehicle.



### KIT FRAME 28 DUCATO



### KIT FRAME 40 DUCATO



## MODELS

	Dimensions	Weight	Item No.
Kit Frame 28 Ducato	37,5 x 34cm	0,3kg	08635-01-
Kit Frame 40 Ducato	49x49cm	0,4kg	08636-01-



# Vent / Turbo-Vent

SUITABLE FOR VAN CONVERSIONS AND CAMPERVANS



Ideal for all vehicle types, this rooflight is also available in a motorised version and allows constant air recirculation.



## COVER FINISH

 White  
(opaque white)

 Crystal  
(tinted transparent)



### TURBO-VENT PREMIUM

Rooflight with motor where all functions are activated by a simple finger touch. Convenient electronic interface with signal LEDs.



### TURBO-VENT

Classic rooflight with 12 V DC variable speed motor.



### VENT

Rooflight without motor equipped with permanent air flow ventilation and mosquito net.

## MODELS

	Vent	Turbo-Vent	Turbo-Vent Premium
Item No.	04329B02- / 04329B02D	03624F02- / 03624F02D	03624H02- / 03624H02D
Cover	White / Crystal	White / Crystal	White / Crystal
Weight	2,8kg	4,6kg	4,6kg
Dimensions	40x40cm	40x40cm	40x40cm
Outside dimensions	45,5x45,5x8,5cm	45,5x45,5x8,5cm	45,5x45,5x8,5cm
Internal dimensions	43x43x1cm	43x43x1cm	43x43x1cm
Feeding tension	-	12V	12V
Absorbed power	-	36W	36W
Min. electric input	-	0,3A	0,3A
Max electric input	-	3A	3A
Maximum air flow	-	35m <sup>3</sup> /min	35m <sup>3</sup> /min







# Vent F Pro

SUITABLE FOR VAN CONVERSIONS AND CAMPERVANS



The high-range rooflight, sturdy, functional and with elegant design. It can be fitted with the optional Kit Turbo-Vent F so as to convert a simple rooflight into motorized fan.



## COVER FINISH

Crystal (tinted transparent)

## MODEL

	Cover	Weight	Dimensions	Outside dimensions	Internal dimensions	Inside light	Item No.
Vent F Pro	Crystal	4,7kg	40x40cm	56,6x53,1x9,2cm	49x48,6x3,5cm	34,4x34,4cm	07380-02-

## ADD TO YOUR VENT F PRO



### KIT TURBO-VENT F PREMIUM

Equipped with "Touch" electronic control unit and Polar Control\* thermostat as standard.



### KIT TURBO-VENT F

Standard version equipped with Polar Control\* thermostat.

Kit Turbo-Vent



\* Polar Control function automatically activates the ventilation depending on the difference among measured ambient temperature, required temperature and outdoor temperature.

# Turbo-Kit

SUITABLE FOR VAN CONVERSIONS



An additional fan for your vehicle, quick and easy to install on almost all models of rooflights. Simple to connect to the electrical system, thanks to the 12Vdc power cable.

Turbo-Kit



## FEATURES

Power supply	Power consumption	Minimum absorption	Maximum input	Maximum air flow
12V	4W	0,2A	0,33A	7,2m <sup>3</sup> /min



Polarity inverter: from fan to aspirator

# Accessories

To make your Fiamma rooflight even more efficient, we have designed a range of accessories.

Vent Accessories





# LEDs for awnings

SUITABLE FOR VAN CONVERSIONS AND CAMPERVANS



Lots of solutions to illuminate your space using the arms and rails of the awning. All systems are LED, to guarantee an excellent level of lighting and very low power consumption.

## FEATURES:

- Average LED duration 25,000 hours
- Super Bright LEDs,  $\varnothing$  5mm
- 12 V power supply

## MODELS



### LED AWNING CASE

LED light bar to be inserted in the special case box housing of F45s winch awning. Delivered as standard in the length of 2.5 m. The optional 50cm kit is available.  
Suitable for: F45s.



### KIT AWNING LED

Installation by simply pushing on the lead bar, for a permanent fixing. It is composed of two 12V 9 LED low consumption light strips and 5m of cable.  
Suitable for: F45s.



### KIT LED STRIP AWNING F80

Specific for F80s awnings consisting of a 5m LED COB\* sticky strip and PVC lens, which can be easily shortened. To be inserted into the internal profile of the front and case box.  
Suitable for: F80s.



### RAFTER LED VAN

Specific for F40van and F40van, equipped with COB LEDs\*. Fast attachment directly to the arms of the awning, for an optimally taut fabric at all times. Power supply via jack and cigarette lighter (12V).  
Suitable for: F43van 270, F40van and F45s 260.



### RAFTER LED

Restyling featuring easier and more practical awning attachment, COB LEDs\* and power supply via jack connector and cigarette lighter (12V socket).  
Suitable for: F45s, F80s.



### AWNING ARMS LED

4 LED lights (2 pairs) that are easily attached to the articulated arms of the awnings and remain mounted allowing the awning to be closed completely. Complete with 5m of cable for quick connection.  
Suitable for: F45s, F80s.

\* COB = Chip On Board. COB LED strips are LED strips that create homogeneous lines of light without the classic dotted effect



 MODELS

**new**  
**20**  
**24**
**KIT LED STRIP AWNING F43**

COB LED\* strip for insertion in the F43van awning case box. Available in the standard size of 2.5m.

\* COB = Chip On Board. COB LED strips are LED strips that create homogeneous lines of light without the classic dotted effect

	F45s	F45s minivan	F43van	F80s	F40van
Rafter LED <b>[Restyling]</b>	•	•		•	
Rafter LED Van <b>[Restyling]</b>	•*	•*	•**		•
Awning Arms LED	•	•		•	
Kit Awning LED	•	•			
Kit LED Strip Awning (F80) <b>[Restyling]</b>				•	
Kit LED Strip Awning (F43van) <b>[New]</b>			•		
LED Awning Case / LED Awning Case 50	•				

\* F45s 260  
 \*\* F43van 270

 CHOOSE THE MODEL THAT SUITS YOU

	Rafter LED <b>[Restyling]</b>	Rafter LED Van <b>[Restyling]</b>	Awning Arms LED	Kit Awning LED	Kit LED Strip Awning F80 <b>[Restyling]</b>	Kit LED Strip Awning F43van <b>[New]</b>	LED Awning Case	LED Awning Case 50
Item No.	98655A850	98655A134	98655-849	98655-471	98655Z171	98655Z172	98655-914	98655-915
LED Colour	Cold white	Neutral white	Cold white	Cold white	Neutral white	Neutral white	Cold white	Cold white
Weight	1,4kg	1,4kg	0,3kg	0,13kg	0,3kg	0,3kg	0,25kg	0,06kg





# LED for outdoors

SUITABLE FOR VAN CONVERSIONS AND CAMPERVANS



To illuminate your outdoor space.  
All systems are LED, ensuring optimum lighting and very low power consumption.

## FEATURES:

- Average LED duration 25,000 hours
- Super Bright LEDs,  $\varnothing$  5mm

## MODELS



### LED AWNING LIGHT

External LED light for awnings, which can be installed under the awning case box or above the entrance door. Complete with elegant plastic end caps.



### LED WARNING SOLAR

System of two intermittent signal lights. Ideal to be positioned around your motorhome and caravan to highlight a dangerous area. Each light is provided with a solar panel that recharges the internal batteries during the day. The internal rechargeable batteries are capable of being recharged around 500 times.



### LED SENSOR DOOR LIGHT

With PIR and light sensor, it only lights up at night when a person approaches your vehicle; the lights remains on for 60 seconds.

## CHOOSE THE MODEL THAT SUITS YOU

	LED Awning Light	LED Warning Solar	LED Sensor Door Light
Item No.	98655-848	98655-885	98655A884
LED Colour	Cold white	Intermit. red	Cold white
Weight	0,4kg	0,17kg	0,5kg







# Water pumps

SUITABLE FOR VAN CONVERSIONS AND CAMPERVANS



Safe and reliable pumps, to guarantee a constant and high flow on your vehicle.

## FEATURES:

- Anti-vibration base
- Motor with thermal protection
- Standard stainless steel filter removable for easy cleaning
- It can be installed in any position, can run dry without damage
- Power supply: 12 V

## MODELS



### AQUA F

Equipped with an internal diaphragm made in a single piece to ensure its watertight seal. 4 chambers for high flow of water. Standard filter. Available in 10 and 13 litres versions.



### AQUA 8

Aqua 8 is the classic self-priming pump with incorporated filter and anti-vibration Silent Plate base as standard. Angle and straight connectors for 13mm pipes included. Available in 7 and 10 litres versions.

## ACCESSORIES



### A20

Ideal complement to both Fiamma and non-Fiamma pumps. A20 expansion tank eliminates pulsating pump operation and supplies a constant flow of water in the required quantity. The internal pressurized diaphragm provides a smooth, surge-free flow of water.

## CHOOSE THE MODEL THAT SUITS YOU

	Aqua F (13 litres)	Aqua F (10 litres)	Aqua 8 (7 litres)	Aqua 8 (10 litres)	A20 [Restyling]
Item No.	07073-01-	07073A01-	01216C01-	01216B01-	02478-02-
Weight	2,2kg	1,4kg	1,5kg	1,5kg	0,3kg

Power supply: 12V

The 10L model is indicated for standard circuits, where a high flow rate is not required, it has low power consumption and is a more economic version, with fittings provided as an option. The 13L version is suitable for circuits where a high flow rate is required.





# Tanks

SUITABLE FOR VAN CONVERSIONS AND CAMPERVANS



Water is a precious resource that you need to take care of. Both blue tanks, made of food grade material, and the waste water grey tanks are easy to fill, transport and empty. Choose them according to function and capacity.

## FEATURES:

- Watertight cap
- Easy to transport
- Compact size

## HOMOLOGATIONS

- DM 174/2004
- EU 10/2011
- DM 21/03/1973

## MODELS



### ROLL-TANK 23F

Convenient portable water tank with easy access discharge cap. Compact size (fits through normal vehicle doors). Complete with extra cap for immersion pump (not included).



### ROLL-TANK 40F

Portable water tank, easy grip handle and silent rubber wheels make transportation easy even on gravel. Easy cleaning wide filler cap. The equipment consisting of bayonet cap and hose connector, used for direct filling of the tank, is available as an optional accessory.



### TANK 70

Large water tank, it can be installed vertically or horizontally, it is complete with all the fittings.

## WASTE WATER MODELS



### ROLL-TANK 23W

Convenient portable waste water tank with easy access discharge cap. Compact size (fits through normal vehicle doors). Capacity: 22,5l.



### ROLL-TANK 40W

Waste water tank, includes a vent valve and level indicator. Connects to the valve of the motorhome tank via the drain tube. The 45° angle adapter for drain is included. Capacity: 35l.

## CHOOSE THE MODEL THAT SUITS YOU

	Weight	Item No.
Roll-Tank 23 F	2,4kg	02428A01A
Roll-Tank 40 F	3,8kg	08307-02A
Tank 70	4,4kg	08306-01-
Roll-Tank 23 W	2,4kg	02428A01-
Roll-Tank 40 W	3,9kg	08307-01-





# Levelling systems

SUITABLE FOR VAN CONVERSIONS AND CAMPERVANS



The ground on which you park your vehicle is not always perfectly level. That's why we suggest you purchase one of our levelling systems, designed to stabilise each type of vehicle.

## MODELS



### KIT LEVEL UP PREMIUM S

Ideal for van conversions. With three levelling cradles, handle for a safe and easy positioning of the product under the vehicle and high manoeuvrability. The practical Level Bag is included as standard.



### LEVEL UP - KIT LEVEL UP

Ideal for van conversions, campervans and 4x4. Ridged surface to grip to the vehicle's tyres. Consists of three levels, lightweight and easy to clean. The Kit version is complete with Level Bag.



### LEVEL PRO

Ideal for camper vans. Practical self-locking overlapping interlocking levelling system to raise height. Ridged surface to grip to the vehicle's tyres.



### LEVEL SYSTEM MAGNUM

Ideal for van conversions, campervans and 4x4. Practical self-locking overlapping interlocking levelling system to raise height.

## CHOOSE THE MODEL THAT SUITS YOU

	Dimensions	Levels	Capacity	Item No.
Kit Level Up Premium S *	68x28x16cm	3	5,0t	97901-062
Level Up - Kit Level Up	57x20x13cm	3	5,0t	97901-038 / 97901-059
Level Pro	43x17x9cm	-	5,0t	97901-011
Level System Magnum	50x20x9cm	-	8,0t	97901-015

\* This item is not offered for sale to UK customers and must not be imported into the UK or sold to third parties in the UK.

## OTHER ACCESSORIES

Wheel & Grip



Jacks



Anti-sinking bases



Step







# Roof Rail Ducato

SUITABLE FOR VAN CONVERSIONS



To make the most of your vehicle's roof, a complete roof rack system for Fiat Ducato, Citroën Jumper and Peugeot Boxer.

## FEATURES:

- Installation without drilling the vehicle
- Max. load capacity: 150kg
- Two finishes: aluminium and Deep-Black
- Roof Rail Ducato: can be installed on Ducato vehicles with H2 high roof, L1, L2 and L3 lengths Roof Rail
- Ducato Maxi XL: for vehicles with H2 high roof and L4 length
- Roof rail Ducato H3: version for Ducato with H3 high roof and L3 and L4 length

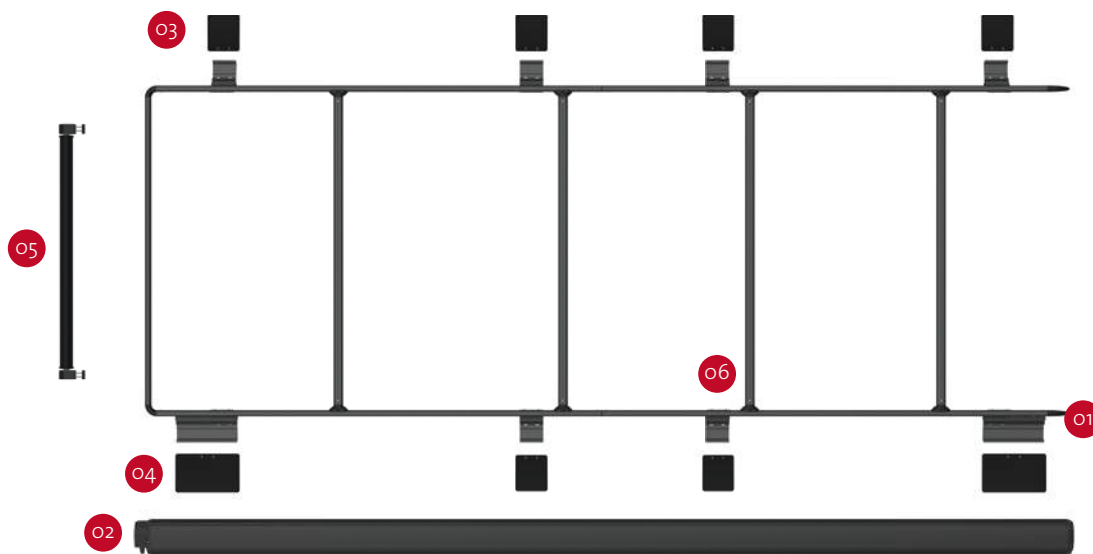

**01 Brackets F80s / F65s**  
Supplied as standard.  
To mount the awning  
without drilling the  
vehicle

**02 F80s**  
Roof awning (to be purchased  
separately). It is ideal to combine  
with Ducato Roof Rail

**03 Kit Roof Rail Ducato Cover Left**  
Optional accessory kit to cover  
the mounting brackets (3 pcs)

**04 Kit Roof Rail Ducato Cover Right**  
Optional accessory kit to cover  
the mounting brackets (3 pcs)

**05 Roller Roof Rail**  
**Add it to the Roof Rail**  
It will be a convenient aid in loading  
and unloading operations

**06 Kit Roof Rail Ducato Extra**  
Pair of additional brackets for  
Ducato Maxi XL Roof Rail

## CHOOSE THE MODEL THAT SUITS YOU

	Roof Rail Ducato * (h 16,5cm)	Roof Rail Ducato * Deep Black (h 16,5cm)	Roof Rail Ducato Maxi XL **	Roof Rail Ducato H3 ***	Roof Rail Ducato H3 - RHD *** <b>[New]</b>
Item No.	05808-01-	05808A01A	05808-02-	05808-03-	05808-04-
Weight	12,0kg	12,0kg	13,5kg	14,2kg	14,2kg

\* can be installed on Ducato vehicles with H2 high roof, L1, L2 and L3 lengths (to reach the desired length you can cut the 2 lateral bars, which are delivered as standard in L3 version)  
\*\* for vehicles with H2 high roof and L4 length. \*\*\* version for Ducato with H3 high roof and L3 and L4 length. Delivered as standard with 4 Fixing-Bar Rail



## ROLLER ROOF RAIL

Roller for loading the roof rack. Facilitates the loading and unloading of canoes, kayaks and other objects from the rear of the vehicle. Ideal to be used with Roof Rail Ducato, Roof Rail Ducato Maxi XL.



# Organizer

SUITABLE FOR VAN CONVERSIONS, CAMPERVANS AND 4x4



When travelling, like at home, it is important that everything is in order and in its place. For this reason Fiamma created the Organizer range, to enable you to neatly organise the space both inside and outside of the vehicle.

## FEATURES:

- Many models
- Easy to install
- Can be installed in 3 different ways: on rail, using eyelets, with Fix Organizer

## MODELS



### PACK ORGANIZER BOX

Spacious organiser box, occupies minimum space when closed.  
Dimensions: 60x36x31cm.



### FIX ORGANIZER

Practical fixing system.  
Dimensions: 5.5x3x1cm.



### PACK ORGANIZER MIX

Practical multi-purpose polyester organiser bin with zip fastener and pop-up opening for minimum space when closed. Its shape and simplicity make it suitable for storing a wide range of objects such as toys or laundry. The 4 bag clamps, supplied as standard, also allow it to be used as a dustbin. Diameter 28cm, height 40cm.



### MEGA BAG ELITE / SMART L

Storage bag for panels and Privacy Room.  
**Mega Bag Elite**

Dimensions: 150x35x35cm.  
Equipped with wheels, internal net pockets with elastic border and reinforcement panel on the bottom and 2 on the sides.

#### **Mega Bag Smart L**

Dimensions: 195x25x25cm.  
Length increased, to hold and carry skis too with internal Velcro fasteners to secure skis and studded holes to allow small amounts of water to escape; with internal pockets.



### MEGA BAG / MEGA BAG LIGHT

New version, proposed alternative to the current bags supplied with Fiamma Privacy Rooms. Useful for storing panels and Privacy Rooms.

**Mega Bag:** 140x27x40cm

**Mega Bag Light:** 140x25x25cm



### CARRY-DOG

Folding dog house, complete with bag and handle for easy transportation, carpet and eyelets to fasten it to the ground. Side windows are with mosquito net which can be rolled up with Velcro. Dimensions: 75x55x49cm.



### PACK ORGANIZER TOILETRY

Container for bathroom fittings.

Dimensions: 30x37x11cm.

Number of pockets: 10.



 MODELS

# Pocket

Pocket



## PACK ORGANIZER L

For little objects.  
Dimensions: 88x39cm.  
Number of pockets: 6.



## PACK ORGANIZER S

For little objects.  
Dimensions: 50x84cm.  
Number of pockets: 11.



## PACK ORGANIZER SEAT

To hang up on the rear part of the seats of your vehicle.  
Dimensions: 43x66x4cm.  
Number of pockets: 4.



## PACK ORGANIZER SHOES

Container for shoes.  
Dimensions: 84x54x18cm.  
Number of pockets: 10.



## PACK ORGANIZER PRIVACY

Optimise the space inside your enclosure and keep everything within reach, thanks to these storage containers that attach directly to the panels.

 CHOOSE THE MODEL THAT SUITS YOU

	Weight	Dimensions	Number of pockets	Triple Fixing*	Function	Item No.
Pack Organizer Box	2,8kg	60x36x31cm	-	-	-	08207-01-
Pack Organizer Mix	0,3kg	ø 28cm - h 40cm	-	-	-	08725-01-
Mega Bag Elite	4,2kg	150x35x35cm	-	-	-	08373-01-
Mega Bag Smart L	1,6kg	195x25x25cm	-	-	-	08374A01-
Mega Bag <b>[New]</b>	1,1kg	140x27x40cm	-	-	-	08843-01-
Mega Bag Light <b>[New]</b>	0,6kg	140x25x25cm	-	-	-	08844-01-
Carry-Dog	2,8kg	75x55x49cm	-	-	-	08201-01-
Pack Organizer Toiletry	0,6kg	30x37x11cm / 30x118x11cm	10	-	Container for bathroom fittings	07515-01-
Fix Organizer	0,1kg	5,5x3x1cm	-	-	-	98655-163
Pack Organizer L	0,5kg	88x39cm	6	●	For little objects	07512A01-
Pack Organizer S	0,4kg	50x84cm	11	●	For little objects	07512-01-
Pack Organizer Seat	0,3kg	43x66x4cm	4	-	To hang up on the rear part of the seats of your vehicle	07514-01-
Pack Organizer Shoes	1,1kg	84x54x18cm	10	●	Container for shoes	07513-01-
Pack Organizer Privacy	0,4kg	115x30cm	4	-	For little objects	07366-01-

\* 3 installation modes: on rail, using eyelets (screws not included), with Fix Organizer (optional)



# Deluxe DJ

SUITABLE FOR VAN CONVERSIONS



For the dedicated ladders for Sprinter, Crafter and Transit vehicles.

One structure for all models and dedicated fixing bars for each vehicle type can be purchased separately.

## FEATURES:

- Tubes ø 30mm and thickness 2mm
- Anodised or painted aluminium
- Non-skid finish
- Step inner width: 28cm - Step total width: 35cm

## COMPOSITION

Kit Bars Deluxe



Deluxe DJ



Complete Deluxe DJ



+

=

Kit Bars

Ladder

Complete ladder

Kit Bars Deluxe Sprinter ≥ 06 /  
Crafter ≥ 06 ≤ 16

Deluxe DJ Sprinter / Crafter

Kit Bars Deluxe Crafter ≥ 17

Deluxe DJ

Deluxe DJ Crafter

Kit Bars Deluxe Transit ≥ 14

Deluxe DJ Transit

## CHOOSE THE MODEL THAT SUITS YOU

	Kit Bars Deluxe Sprinter ≥ 06 / Crafter ≥ 06 ≤ 16	Kit Bars Deluxe Crafter ≥ 17	Kit Bars Deluxe Transit ≥ 14	Deluxe DJ
Colour	Deep Black / Aluminium	Deep Black / Aluminium	Deep Black / Aluminium	Deep Black / Aluminium
Item No.	08772-03A / 08772-03-	08772-01A / 08772-01-	08772-02A / 08772-02-	02426-22A / 02426-22-
Weight	2,2kg	2,1kg	2,0kg	5,5kg
Number of steps	-	-	-	8
Folding	-	-	-	•
Compatible with	Carry-Bike Frame Sprinter / Carry-Bike DJ Sprinter	Carry-Bike Frame Crafter / Carry-Bike DJ Crafter	Carry-Bike DJ Transit	-





# Deluxe DJ Ducato

SUITABLE FOR VAN CONVERSIONS



Outdoor ladders specifically for Fiat Ducato, Citroën Jumper, Peugeot Boxer.

## FEATURES:

- Tubes  $\varnothing$  30mm and thickness 2mm
- Anodised or painted aluminium
- Non-skid finish
- Step inner width: 28cm - Step total width: 35cm

## MODELS

### DELUXE DJ DUCATO

Ladder with 6 steps.  
Installation with Fixing Bar on the left door of the vehicle.  
Combines a Carry-Bike mounted on the right door.



### DELUXE DJ DUCATO H3

Ladder with 6 steps.  
Specific version for vehicles with height H3.



## CHOOSE THE MODEL THAT SUITS YOU

	Deluxe DJ Ducato Deep Black	Deluxe DJ Ducato	Deluxe DJ Ducato H3 Deep Black	Deluxe DJ Ducato H3
Colour	Deep Black	Aluminium	Deep Black	Aluminium
Item No.	02426A09A	02426-09A	02426A17A	02426-17A
Weight	6,5kg	6,5kg	6,9kg	6,9kg
Number of steps	6	6	7	7
Compatible with	Carry-Bike Frame Ducato / Carry-Bike DJ Ducato	Carry-Bike Frame Ducato / Carry-Bike DJ Ducato	Carry-Bike Frame Ducato / Carry-Bike DJ Ducato	Carry-Bike Frame Ducato / Carry-Bike DJ Ducato





# Vehicle covers

SUITABLE FOR VAN CONVERSIONS AND CAMPERVANS



When the journey comes to an end, Fiamma has the solution to protect your vehicle from the elements, dust, pollution and dirt, while waiting to set off on a new adventure.

## MODELS



### COVER TOP

Made of UV-resistant fabric vinyl, easy to tension with ropes or elastic cords, reinforced corners and tie down grommets.

Dimensions: 8.5x5.2m.



### THERMOGLAS XXL DUCATO

Designed for Fiat Ducato, Citroën Jumper and Peugeot Boxer ≥ 2006. Ideal for winter use to completely cover the engine compartment; insulated material suitable for low temperatures. Available in the complete model and "Windscreen" model with only the upper part.



### COVERGLAS

External blinds to protect the cab from the sun and UV rays, improved over previous models and with new light grey colour.

Available in 4 versions:

- Ducato: suitable for Fiat Ducato, Citroën Jumper and Peugeot Boxer ≥ 2006
- VW T5/T6
- Ford Transit H2 and H3 ≥ 2014
- Ford Transit Custom ≥ 2012



### THERMO WALL DUCATO CABIN

Convenient and useful thermal panel to be put between the cabin and the motorhome of Fiat Ducato, Citroën Jumper and Peugeot Boxer chassis after 06/2006, to grant more privacy and heat insulation. Dimensions: 182x150hcm.

## CHOOSE THE MODEL THAT SUITS YOU

	Weight	Item No.
Cover Top	6,0kg	04932-01-
Thermoglas XXL Ducato ≥ 2006	11,0kg	06344A01-
Thermoglas Ducato Windscreen	5,0kg	08041-01-
Coverglas XL Ducato ≥ 2006 <b>[Restyling]</b>	3,5kg	08827-01-
Coverglas VW T5/T6 <b>[Restyling]</b>	3,5kg	08827A01-
Coverglas Ford Transit <b>[Restyling]</b>	3,5kg	08827B01-
Coverglas Ford Transit Custom ≥ 2012 <b>[New]</b>	3,5kg	08827C01-
Thermo Wall Ducato Cabin	1,8kg	06585A01-





# Safe Door

SUITABLE FOR VAN CONVERSIONS



A wide range of safety locks for peace of mind while you are on holiday.



## SAFE DOOR GUARDIAN

Made of sturdy aluminium, without plastic parts. It is installed in place of the standard weak plastic blocks in the living unit, in the same position and using the same fixing holes. Versions for Ducato and Transit are available as well.

## DUO SAFE PRO

Security system to keep the vehicle cabin doors closed from the inside.

Tested on:

- Fiat Ducato, Citroën Jumper, Peugeot Boxer and Renault Master ≤ 2006
- Mercedes Sprinter, Fiat Ducato, Renault Master, Ford Transit ≥ 2006
- Also suitable for Iveco Daily's cabin

### CHOOSE THE MODEL THAT SUITS YOU

	Weight	Item No.
Safe Door Guardian	0,3kg	05388-01-
Safe Door Guardian Ducato > 2009	0,4kg	05388-07-
Safe Door Guardian Ducato > 2006 < 2009	0,4kg	05388-04-
Safe Door Guardian Transit < 2006	0,4kg	05388-03-
Safe Door Guardian Transit > 2006 < 2014	0,4kg	05388-05-
Duo-Safe Pro	1,0kg	05411-02-

## Hygiene

Bi-Pot



Sanitary accessories



## Various

Various

accessories



# Discover the best Fiamma accessories for you



Go on [www.fiamma.com](http://www.fiamma.com) or scan the **Qrcode** below

Click on **Choosing guide - Vehicles configurator** from the **Menu**

Fill in your vehicle **features** and discover which **Fiamma** products are good for you

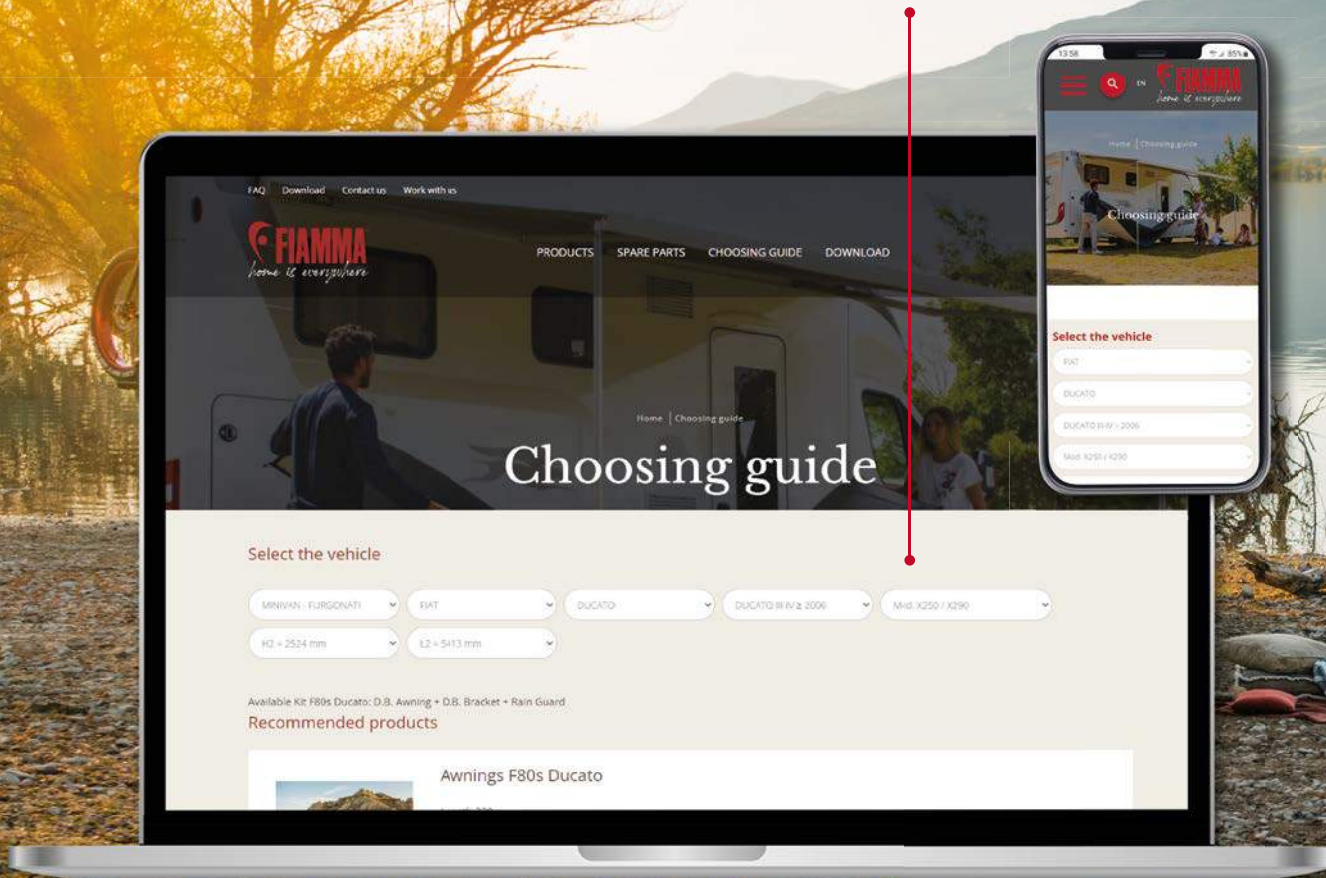

## Video Tutorial

F45s



F35pro



F40van



Carry-Bike  
Frame Ducato







Privacy Room  
Ducato F80s



Privacy Room van  
F45s



Privacy Room  
Light F35pro



Room Van  
Premium F40van











## We love “la dolce vita”

We are Italian, we love to travel, the great outdoors, cycling with our family and enjoy the pleasure of good food with our friends. Where we go we feel at home, just park up. Discover the best products for your vehicle!

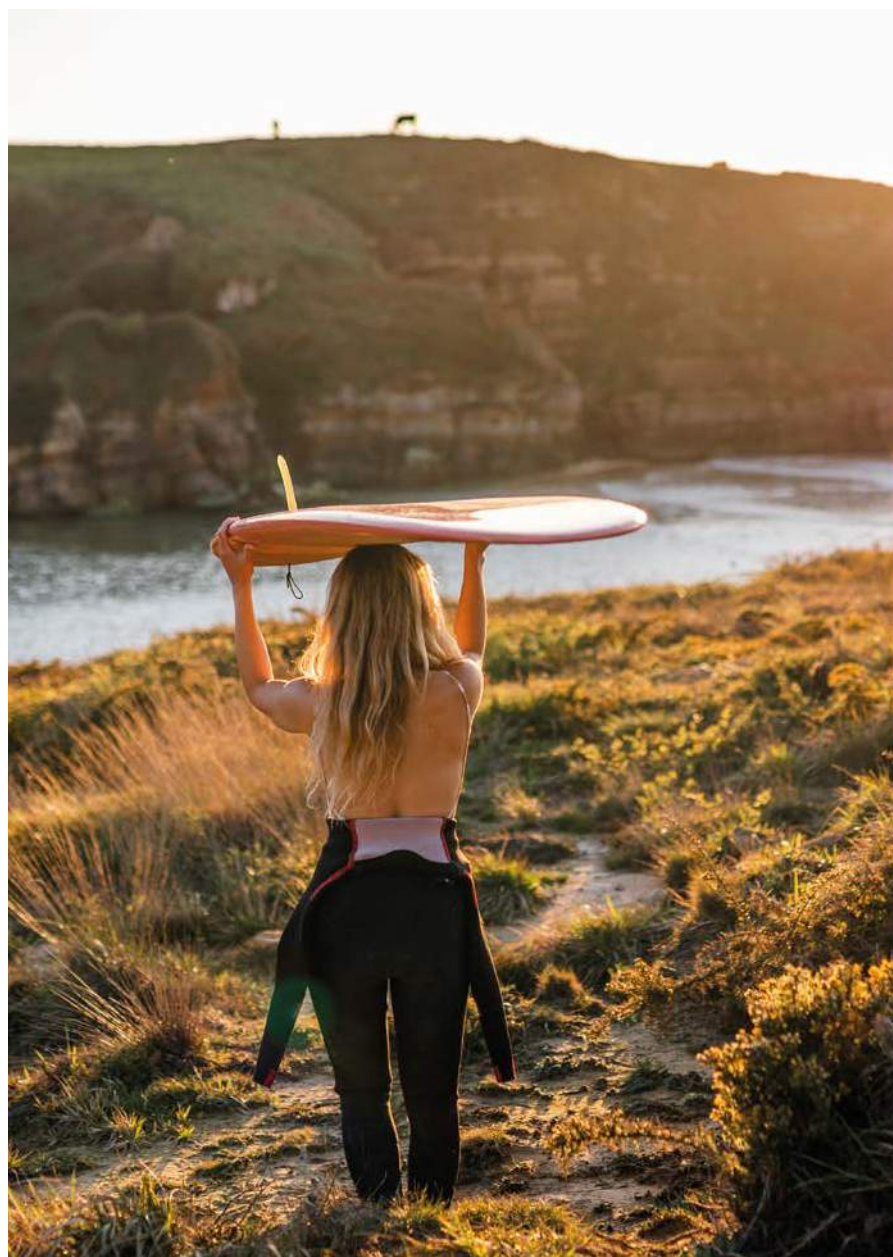



**Fiamma SpA - Italy**

Via S. Rocco, 56 - 21010 Cardano al Campo (VA)

Copyright Fiamma 01/2024. All rights reserved. Printed in Italy.

All illustrations and specifications contained in this catalogue are based on the most recent information at the time of the publication. Fiamma S.p.A. reserves the right to modify at any time, without notice, prices, materials, specifications and models or to cease production of any model.

Fiamma is not responsible for possible mistakes of printing or inexactnesses pertinent to the contents of the catalogue. The colour of the production may be different because of the processes of printing.