



# NC-X<sup>2</sup> Install Manual

48V | 24V | 12V

Version 240415



16680 N 51st Ave Units 4 & 5  
Glendale, AZ 85306  
(480) 576-2489

[www.NomadicCooling.com/Support](http://www.NomadicCooling.com/Support)

## TABLE OF CONTENTS

INTRODUCTION .....	2
ITEMIZED PARTS LIST .....	3
IMPORTANT SAFETY INSTRUCTIONS.....	5
NC-X <sup>2</sup> SPECIFICATIONS .....	6
INSTALLATION INSTRUCTIONS.....	7
ELECTRICAL WIRING SCHEMATICS.....	12
CONTROL PANEL WIRING PHOTOS .....	15
TROUBLESHOOT COMMON ISSUES.....	18
WARRANTY INFORMATION .....	19
RETURNS, CANCELLATIONS, and MISSING PARTS.....	20

## INTRODUCTION

The NC-X<sup>2</sup> Air Conditioner ("AC unit") is designed and intended for installation on the roof of a recreational vehicle during or after the vehicle is manufactured.

The NC-X<sup>2</sup> can be installed by one person with brief help from one additional person. Reading this installation manual in its entirety first will ensure the proper installation and function of the NC-X<sup>2</sup>.

 **Nomadic**  
COOLING CO  
16680 N 51st Ave Units 4 & 5  
Glendale, AZ 85306  
(480) 576-2489  
[www.NomadicCooling.com/Support](http://www.NomadicCooling.com/Support)

Keep a record of the following information:

- 48V
- 24V
- 12V

Model **NC-X<sup>2</sup> Rooftop AC Unit**

Serial No. \_\_\_\_\_

Date Purchased \_\_\_\_\_

Installed By \_\_\_\_\_

Nomadic Cooling reserves the right to modify appearance and specifications without notice.



Always bench test AC unit before installing.



Check to ensure all required parts are included (see page 3).

Get social with us!



@nomadiccooling

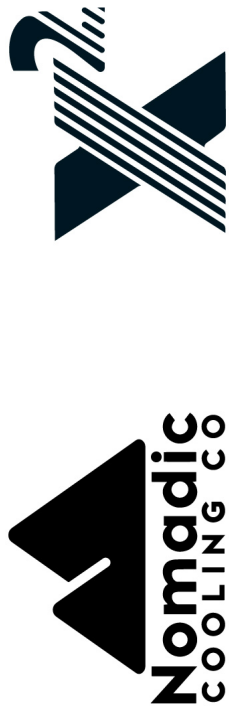

# ITEMIZED PARTS LIST

## PARTS LIST

### NC-X<sup>2</sup> AC Unit (Host Box)

ID	Qty	Part Name	
A	1	NC-X <sup>2</sup> Air Conditioner (black or white)	<input type="checkbox"/>
B	1	Foam Gasket (14.25" x 14.375" interior dimension)	<input type="checkbox"/>
C	2	Crossbars (foam-wrapped)	<input type="checkbox"/>
D	1	Flush Mount Metal Faceplate (in foam pouch)	<input type="checkbox"/>
E	9	Faceplate Screws (black)	<input type="checkbox"/>
F	4	M8 Mounting Bolts	<input type="checkbox"/>
G	4	M8 Mounting Nuts	<input type="checkbox"/>
H	4	Mounting Bolt Lock Washers	<input type="checkbox"/>
I	4	Mounting Bolt Washers	<input type="checkbox"/>
J	1	Remote Control	<input type="checkbox"/>
K	1	Leveling Strip	<input type="checkbox"/>
L	1	Foam Air separator	<input type="checkbox"/>
M	1	Boxed and bagged Control Panel and wire harness	<input type="checkbox"/>
N	1	Rooftop Template with cutout for 14x14" opening	<input type="checkbox"/>
O	2	Plastic Spacers (optional) for Crossbars (no trim ring)	<input type="checkbox"/>

### DIY Kit (Optional)

P	1	Power Bundle, incl. fuse, connectors, and terminals	<input type="checkbox"/>
Q	1	NC-X <sup>2</sup> Trim Ring (optional for installation)	<input type="checkbox"/>
R	1	Template cutout for 14x14" opening (refer to N)	<input type="checkbox"/>
S	20	Zip Ties 10 large + 10 small) and Sticky Plates (10)	<input type="checkbox"/>
T	1	Tube of Polyurethane Adhesive Sealant	<input type="checkbox"/>
U	1	Wide Thermo Tape (5 ft) for Air Separator	<input type="checkbox"/>
V	1	Four 5/16" Stainless Steel Terminals, 3/4" Heat Shrink Wraps (3 red, 1 black), and Thread-locker	<input type="checkbox"/>

Boxed control panel in anti-static bag and pre-attached wire harness.

Power bundle with Anderson or Anderson-style connector, correct fuse and ring terminals. 48V bundle has these parts included as separate components, and are not pre-installed as shown for 12V and 24V models.



← **AC Unit / Shroud**

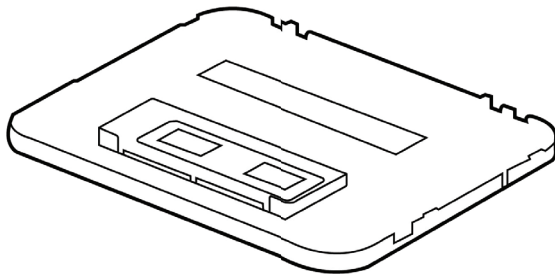

← **AC Base Plate**

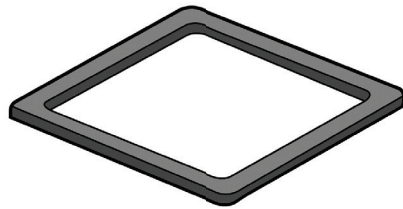

← **Foam Gasket**

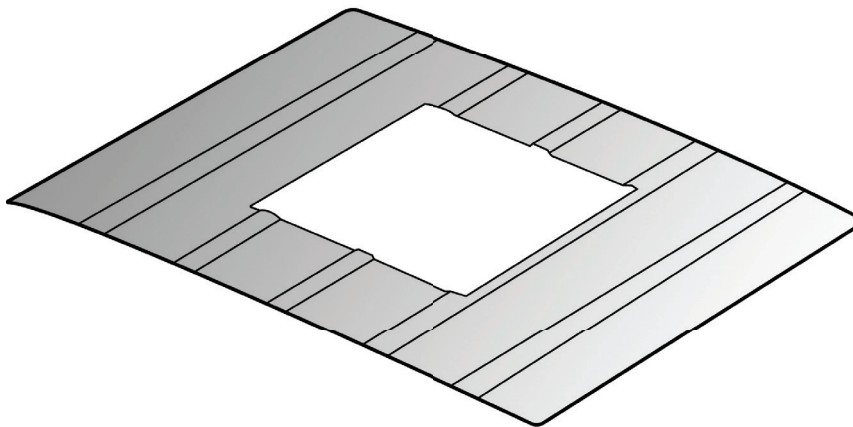

← **Vehicle Roof**

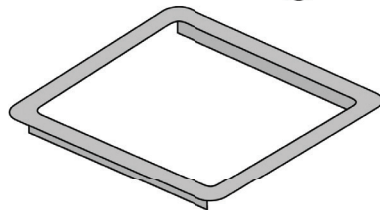

← **Optional X2 Trim Ring (DIY Kit)**

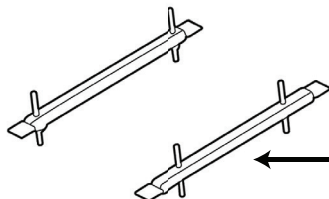

← **Crossbars**

## IMPORTANT SAFETY INSTRUCTIONS

This manual contains safety guidelines and instructions that can aid in reducing or eliminating the risk of accidents and injuries.

### A. Recognizing Safety Information

The safety alert symbol is utilized to notify potential physical injury hazards. To avoid possible injury or death, follow all safety messages that come after this symbol.

### B. Understanding Signal Words

Signal words identify safety and property damage messages and indicate the degree of hazard seriousness.



**WARNING** is used for hazardous situations that could result injury (including death, severe, moderate or minor injury if not avoided).



**NOTICE** is used for situations that could result in AC unit or vehicle damage or unnecessary complications in the installation process.



**HELPFUL TIP** is used for useful information or best practices.

### C. Supplemental Directives

To avoid potential injury and even death, read and follow all of the safety information and instructions.

Read and comprehend these instructions before installing, using, servicing, or maintaining this AC unit. Poor installation, operation, servicing, or maintenance of this AC unit can result in severe injury. Follow all instructions.

The installation must comply with all applicable local and national codes, including the latest edition of the following standards:

#### USA

- ANSI/NFPA70, National Electrical Code (NEC)
- ANSI/NFPA1192, Recreational Vehicle Code

#### CANADA

- CSA C22 1. Parts I & II, Canadian Electrical Code
- CSA Z240 RV Series, Recreational Vehicles

### D. General Safety Messages

**WARNING** - Failure to follow the subsequent warnings could lead to death or serious injury.

- A qualified service technician **MUST** install or service this product.
- Do **NOT** modify this product in any way. Modifications can be extremely dangerous and void any warranties.
- Do **NOT** add any devices or accessories to the AC unit unless specifically authorized in writing by Nomadic Cooling Co.

# NC-X<sup>2</sup> SPECIFICATIONS



OFF-GRID AIR CONDITIONING SYSTEMS FOR VANS, RVS & RIGS



PRODUCT:  
MODEL:

NC-X<sup>2</sup> Rooftop AC Unit  
48V/24V/12V AW/OBS

Shroud available  
in Arctic White  
or Obsidian Black.

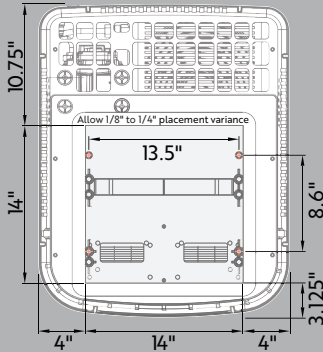
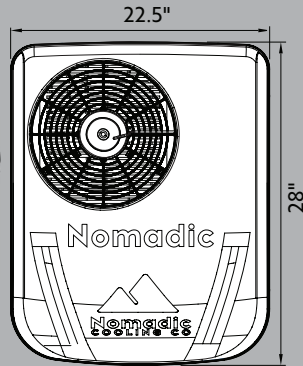

Engineered  
to fit 14"x14"  
industry-standard  
rooftop opening.

Powerful cooling,  
and 40% smaller  
than comparable  
units on the market!

MODEL	48V	24V	12V
Current ECO Mode	8A	17A	27A
Current MAX Mode	15A	35A	55A
Rated Power	1,070W	900W	720W
Fuse Size	30A	50A	70A
Rated Cooling Capacity (BTU)	12,150	10,280	8,188
Power Cord Specification	10 AWG	8 AWG	4 AWG
Refrigerant	R134a @ 450g ± 30g		
Refrigerant Oil	POE68		
Speed Range	1,000 to 3,000 RPM		
Weight	44 lbs		
Interior Faceplate Dimension	16¼" x 16¼" (flush mount)		
Noise (Decibels)	≤ 60 dBA		
Operation Modes	Auto/ECO/MAX/Fan		
Min-Max Temp Settings	54°F to 89°F		
Warranty	One (1) Year + Extension Option		



Flush-mounted, powder coated  
Obsidian Black interior faceplate.



Modern, crisp  
LCD panel



Remote control  
included

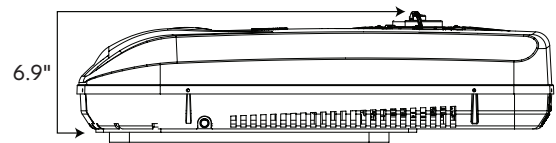

Our quietest, lowest profile AC unit yet!  
48V, 24V and 12V systems available



User Installation and Operation Guide  
available at [NomadicCooling.com](http://NomadicCooling.com)

**GO FURTHER  
IN COMFORT**

[www.NomadicCooling.com](http://www.NomadicCooling.com) | 480-576-2489 | 16680 N. 51st Ave Suites 4-5, Glendale, AZ 85306

# INSTALLATION STEPS

1. The NC-X2 is designed to fit an industry standard 14"x14" opening. If you need to cut a rooftop opening, mark the interior ceiling using the cardboard template provided in the host box.



Never cover AC top fan. Do not cut into structural beams.



When determining AC unit location, be sure to allow for the 22.5" x 28" shroud when positioned on the roof. Make sure there are no electrical or other encumbrances in the way.

2. Make sure the planned opening is centered from all four sides. This gives the best chance for easy installation.

Center the opening between the ribs of the interior ceiling.

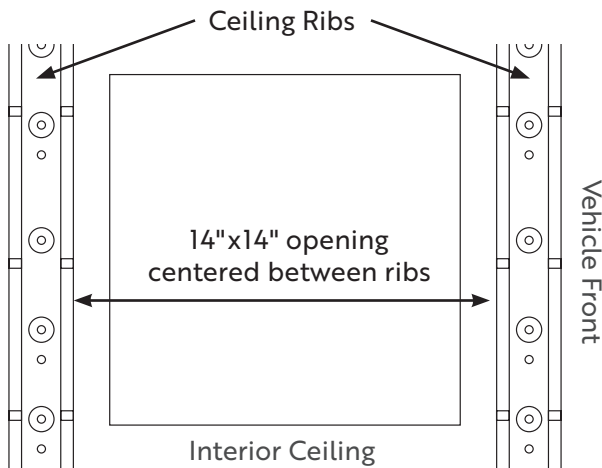

Using the 14"x14" template provided, mark the four corners with a permanent marker.

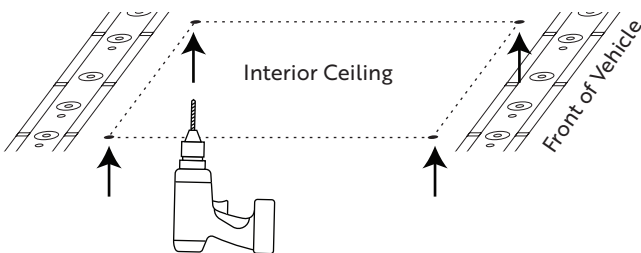

3. Drill each corner of your markings through the interior roof using a 1/8" bit.



On the exterior rooftop, use painter's tape and a permanent marker to draw your 14"x14" cutlines from hole to hole. Make multiple passes with the permanent marker.

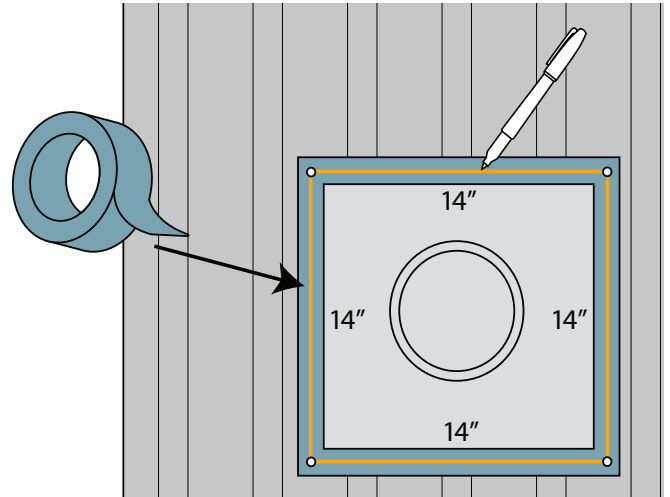

If you make a mistake replace the tape and try again. Measure repeatedly to make sure your lines create a perfect 14"x14" square.

4. Cut on your lines on the rooftop using a jig saw, nibbler or cutting wheel.

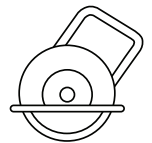
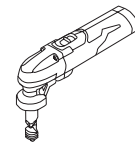
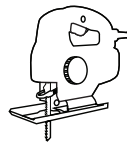

Use a sander or file to smooth out the rough edges after cutting.

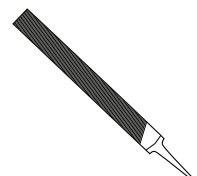
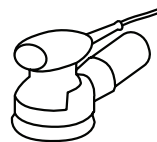

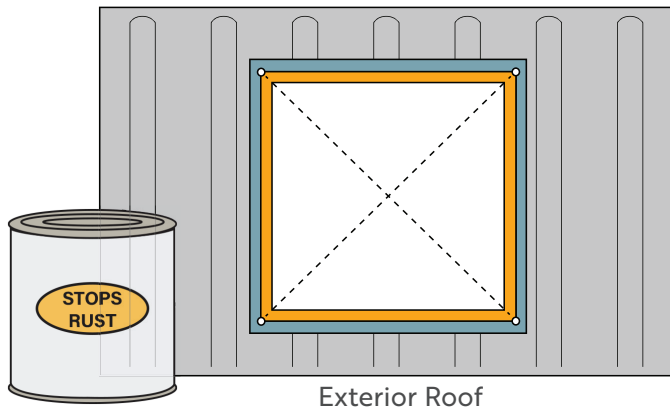

5. **Paint** around the edges of the cut roof opening to prevent rust. You can use any color rust-preventative paint.

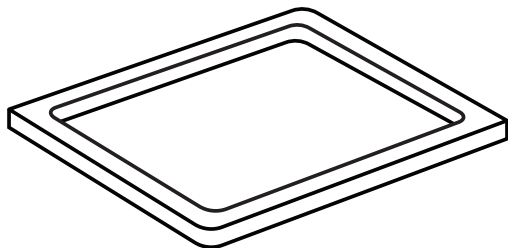

6. **Remove tape** and clean surface.
7. **Remove waterproof gasket** from box.



-  Make sure area/paint is clean, dry and clear of all debris.
-  Use alcohol wipes or PrepSol to remove oil or wax from vehicle roof.

If placing gasket over a high or uneven roof surface, remove small amounts of the 14"x14" gasket to match roof contours.

-  Use blade to cut away gasket if needed.

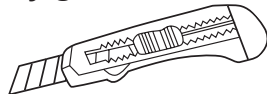

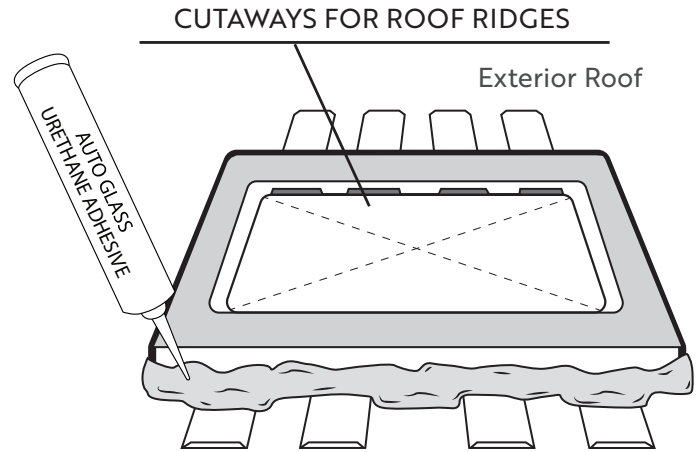

-  Remove gasket adhesive only after making any necessary cuts. Place the gasket sticky side down.

8. **Apply polyurethane adhesive sealant** (included in DIY kit) around 14"x14" gasket.



9. **Gently place AC unit on roof** over gasket. Inner gasket dimension is 14"x14", outer dimension is 16.25"x16.25". Measure side-to-side until centered on all four sides.

-  Be careful not to puncture, rip or tear the gasket with AC unit's mounting bolts.
-  Do not put adhesive on top of gasket.
-  Do not damage electrical components when placing AC unit.

10. **Adhere optional leveling strip** behind the foam gasket.

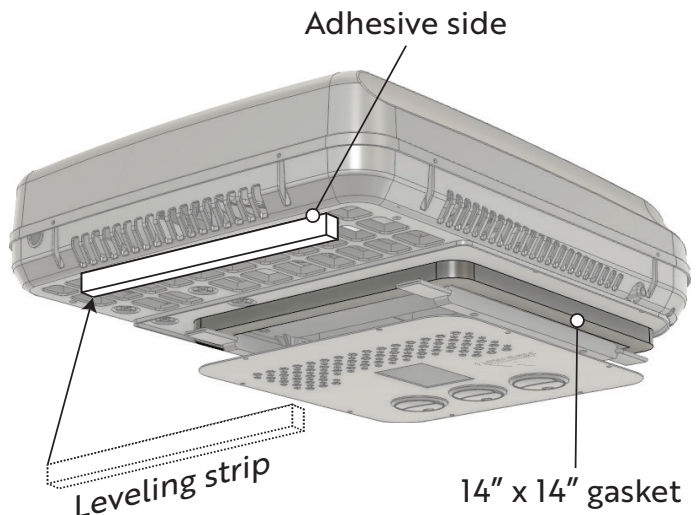



**11. From inside the vehicle add the crossbars to attach AC unit to the roof. Locate the mounting bolts, washers and nuts.**

 Do not use electric drill on crossbars.

**12. If possible with your particular build, we recommend using a trim ring to provide additional support around the rooftop opening. The DIY kit includes a Nomadic Cooling X<sup>2</sup> trim ring. Professional upfitters typically create their own custom trim rings.**

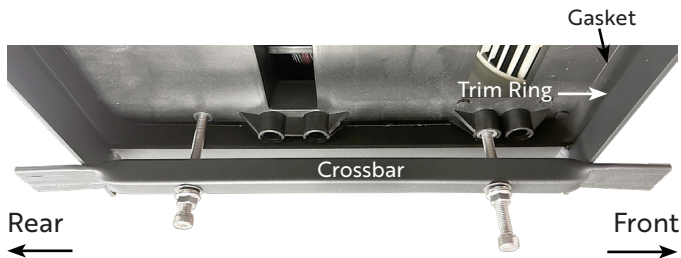

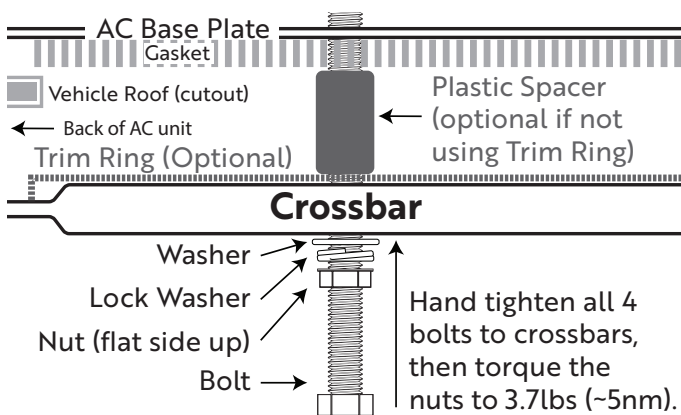

**13. Add the nut, washer and lock washer to each of the four bolts that screw into the AC unit base plate through the crossbar.**

Hand-tighten all four bolts to the AC unit. Do not over tighten! Once all four bolts are hand-tight, torque the lock nuts to 3.7 lb to secure the crossbars to the AC unit, and the AC unit to the roof.



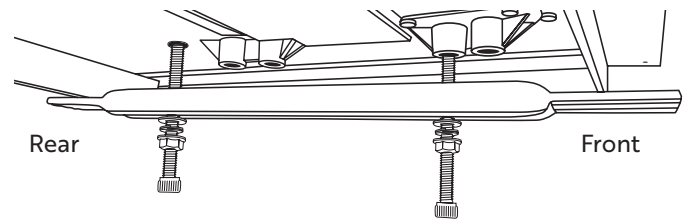

With optional Trim Ring:

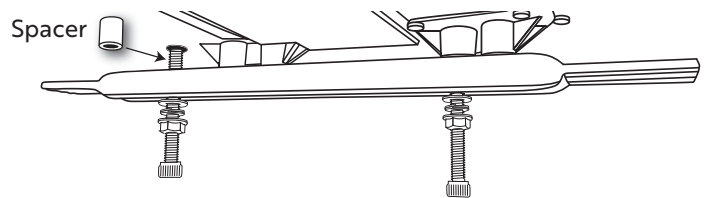

 If NOT using a trim ring, you may use the optional plastic spacer for the two rear bolts, between the crossbars and the AC unit base.

Without Trim Ring and with optional spacer:



 During the installation process, if the locking nut is installed too tightly, it may cause deformation of the AC unit base plate. The spacer can play a limiting role, with any excess locking force acting on the spacer instead of the AC unit base plate.

 A sticker found on the bag of bolts may say to tighten to 5.0 lbs. of torque, please disregard and use the recommended 3.7 lbs.



 AC unit will help to create pressure. When securing AC unit to the vehicle, increased compression of the gasket will level the unit against the roof. No light should be visible.

 Do not over-tighten mounting bolts. Bolts will rotate if over-torqued, and may break from AC base plate. Over-tightening will void warranty.



Our gaskets are used for vibration absorption. It is very high density and can't be compressed more than 10%. Use gasket tension to control AC unit's distance from roof surface.

AC unit should be resting on foam gasket and not on the vehicle's roof.

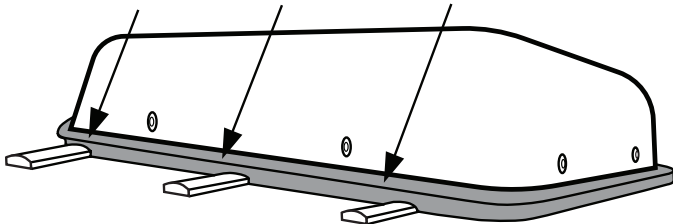

Over compression of the unit to the roof may cause the internal fan to rub against the fan housing.



Be sure the fan blades rotate freely prior to starting the unit.

**12. Install and connect LCD control panel** before connecting to power to avoid blowing internal fuse.



An appropriately-sized fuse must be placed between your power source and the AC unit:

**48V = 30A fuse**

**24V = 50A fuse**

**12V = 70A fuse**

**13. Connect DC power wires to unit.** "Quick Connection to DC Wiring Harness" included. 12V systems use an Anderson connector, 24V and 48V systems use a similar Anderson style connector.

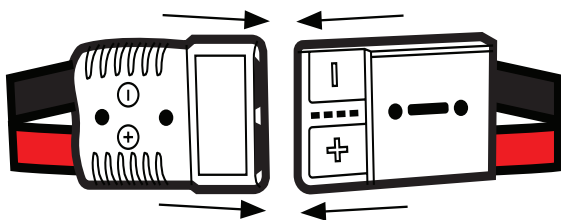

Make sure wiring is appropriately sized and is no smaller than 4AWG.

**14. Attach LCD control panel and AC wiring harnesses.**

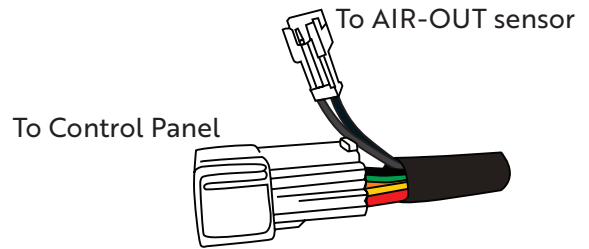

**15. Attach thermostat wires to control panel wiring harness.**

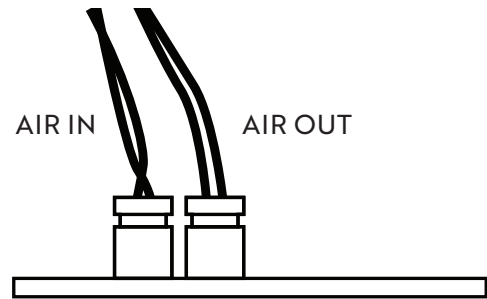

**Details of control panel connections are shown in electrical diagram on page 12.**



Condenser is always to the left of the black wire. Be careful not to break these wires.

**16. Use the foam separator** to properly separate hot air from cold air as it enters and exits the AC unit.

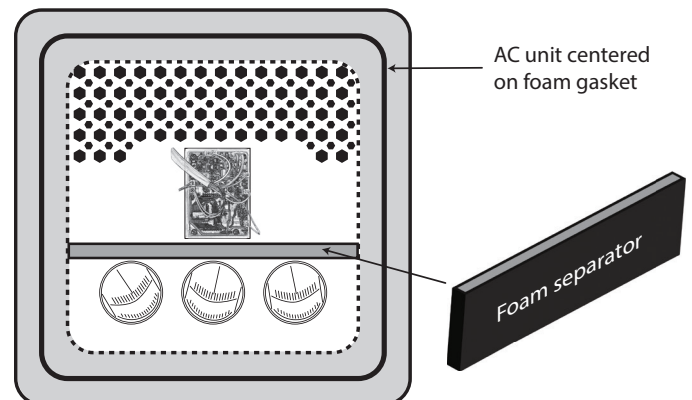

**17. Use heat resistant tape** to secure the air separator in place. Use your best judgment on how much tape to use and where to adhere it, as every installation is different. The tape helps the air separator keep the warm and cool air separated.

**18. Test** all connections between the power source and the unit for excessive heat during normal operations.

**19. Install faceplate.** Line up the faceplate vents with the air-out fan openings in the AC base plate. Use 8 screws (black screws were included in installation kit) that will match your vehicle interior to secure the faceplate to the ceiling.

 The faceplate does not screw into the AC unit base. It attaches (flush mounted) to the vehicle's ceiling directly.

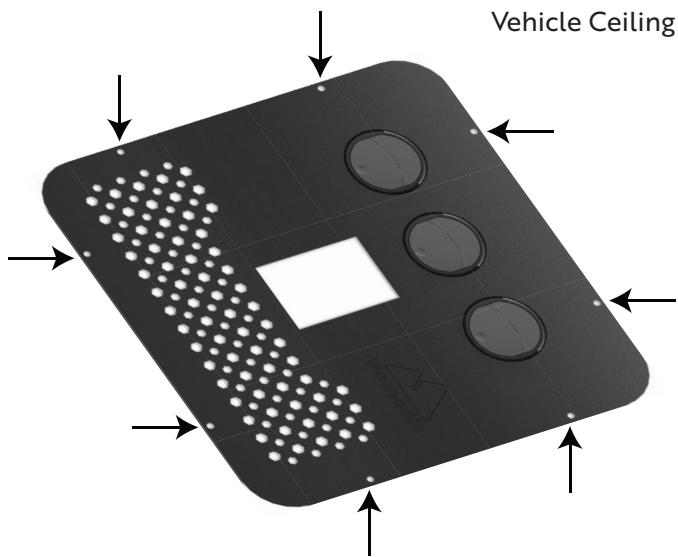

**Congratulations!**

*Your Nomadic Cooling X<sup>2</sup> AC unit rooftop installation is complete. Now...*

**GO FURTHER  
IN COMFORT** 

## Exploded NC-X<sup>2</sup> Components



# Electrical Wiring Diagram



**Nomadic**  
COOLING CO

**48V System**  
Brushless Blower

Legend	Wire Diameter
—	20 AWG 0.5mm <sup>2</sup>
- - -	16 AWG 1.5mm <sup>2</sup>
•••••	12 AWG 4.0mm <sup>2</sup>
—	10 AWG 6.0mm <sup>2</sup>
—	8 AWG 10mm <sup>2</sup>

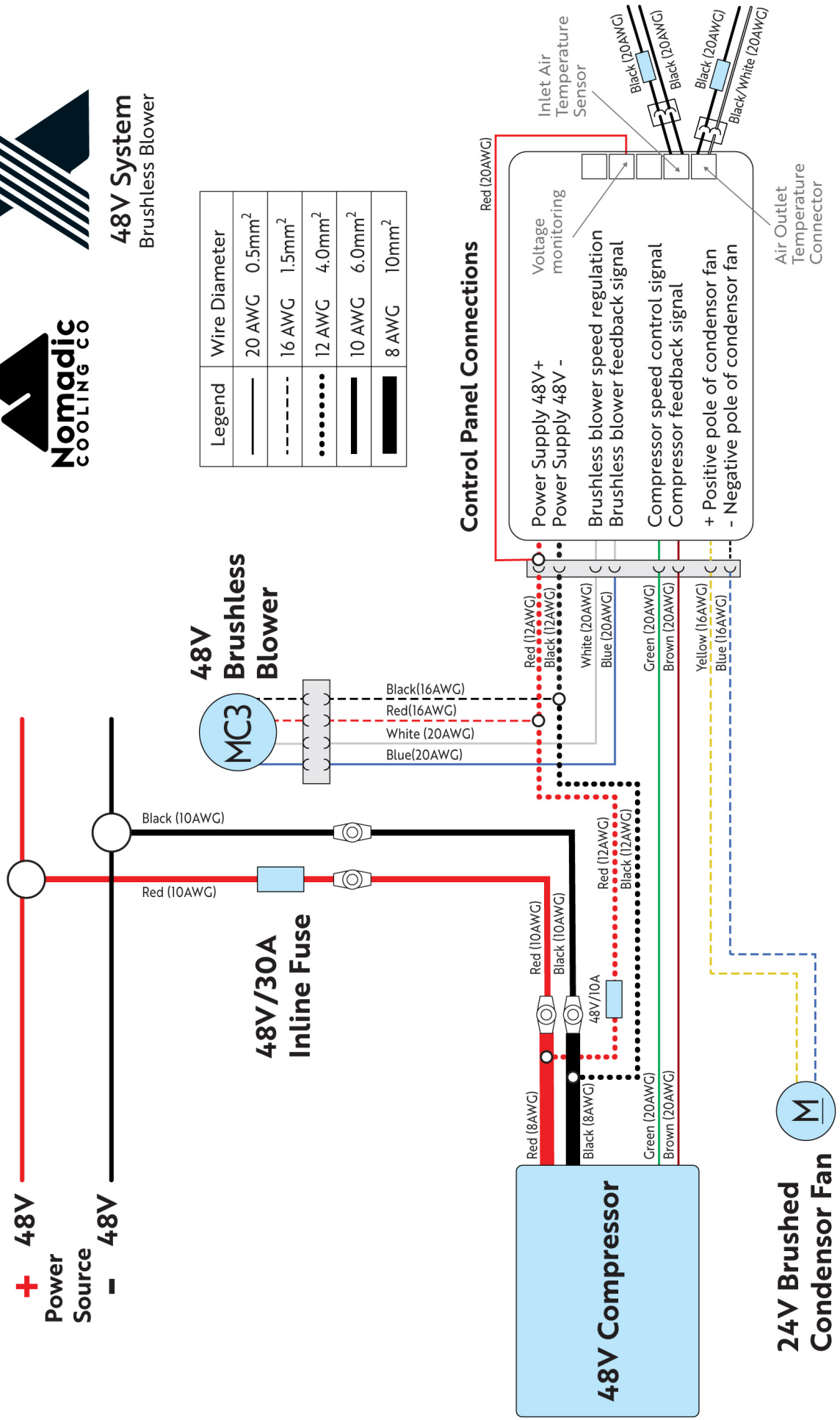

## Control Panel Connections

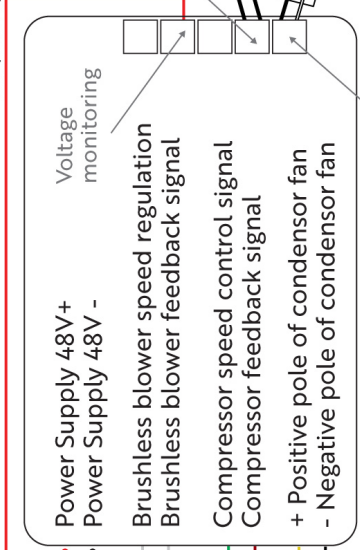

**24V Brushed**  
**Condenser Fan**

# Electrical Wiring Diagram



## 24V System Brushless Blower

Legend	Wire Diameter
—	20 AWG 0.5mm <sup>2</sup>
- - - - -	16 AWG 1.5mm <sup>2</sup>
•••••	12 AWG 4.0mm <sup>2</sup>
—	8 AWG 10mm <sup>2</sup>

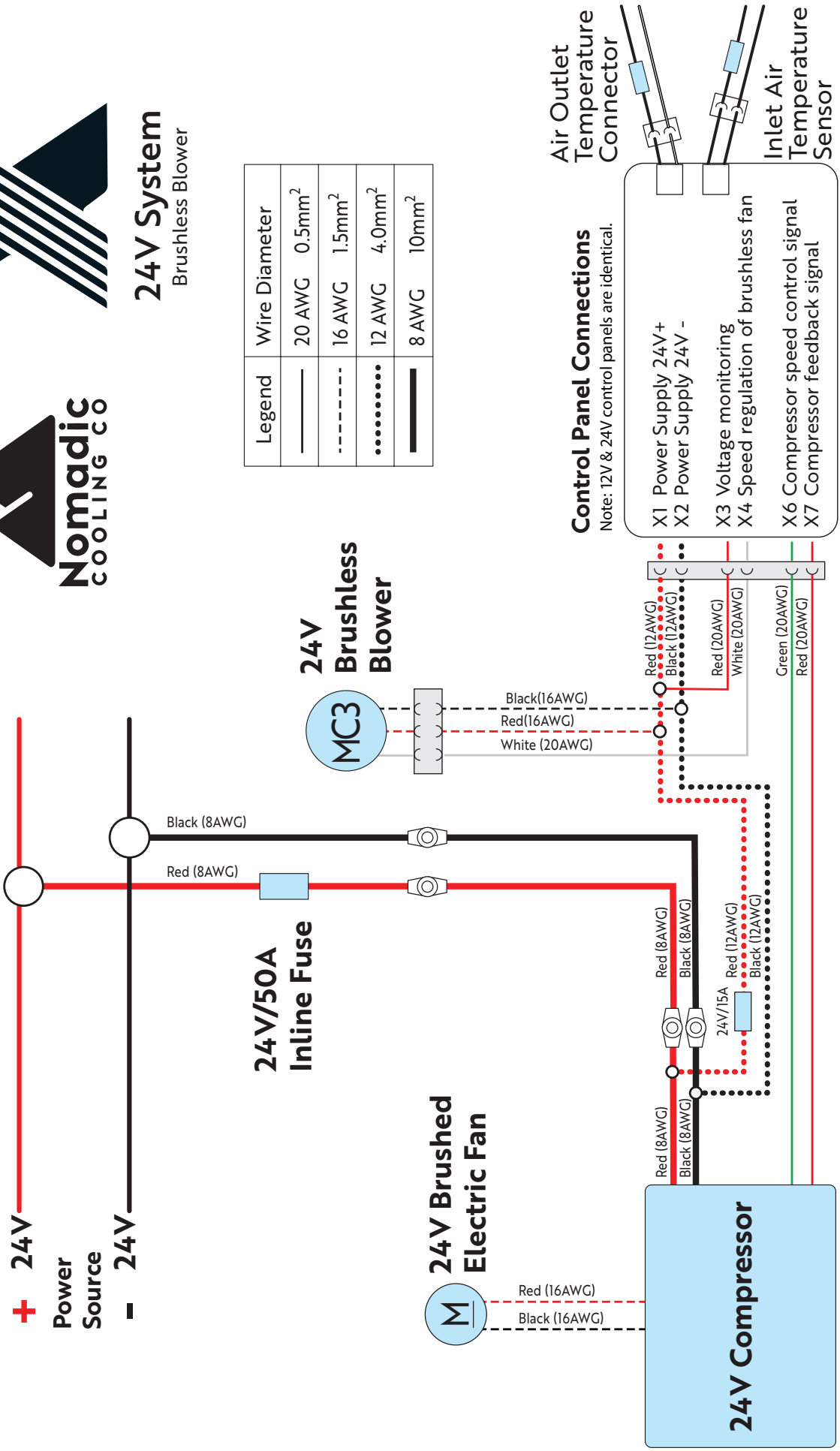

**Control Panel Connections**  
Note: 12V & 24V control panels are identical.

- X1 Power Supply 24V+
- X2 Power Supply 24V -
- X3 Voltage monitoring
- X4 Speed regulation of brushless fan
- X6 Compressor speed control signal
- X7 Compressor feedback signal

# Electrical Wiring Diagram



**Nomadic**  
COOLING CO

**12V System**  
Brushless Blower

Legend	Wire Diameter
—	20 AWG 0.5mm <sup>2</sup>
- - - - -	16 AWG 1.5mm <sup>2</sup>
.....	14 AWG 2.5mm <sup>2</sup>
—	6 AWG 16mm <sup>2</sup>
—	4 AWG 25mm <sup>2</sup>

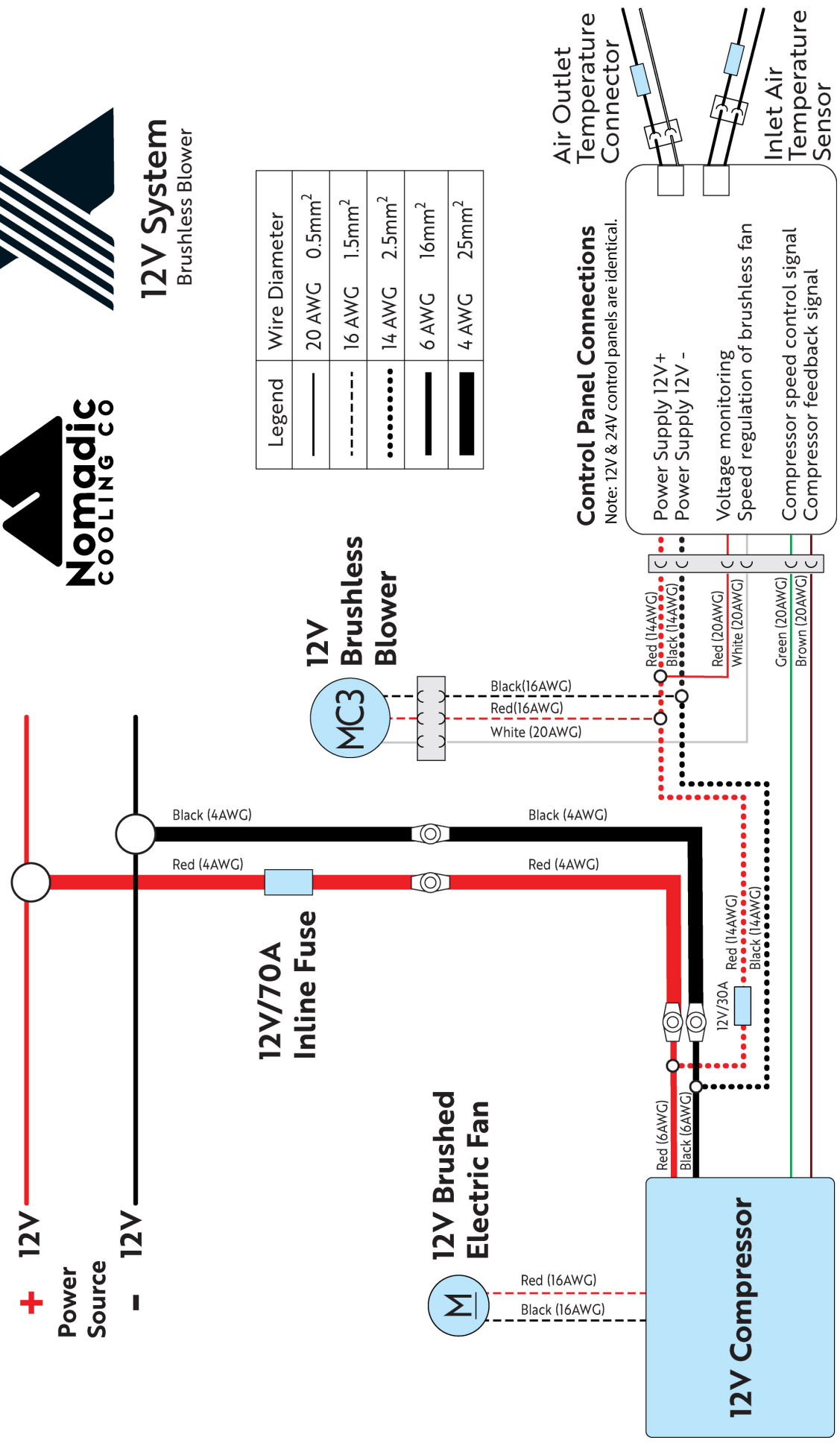

**Control Panel Connections**  
Note: 12V & 24V control panels are identical.

- Power Supply 12V+
- Power Supply 12V -
- Voltage monitoring Speed regulation of brushless fan
- Compressor speed control signal
- Compressor feedback signal

This is a properly wired LED Control Panel for the X<sup>2</sup> (24V and 12V) models with brushless blower.



24V | 12V  
Brushless Blower

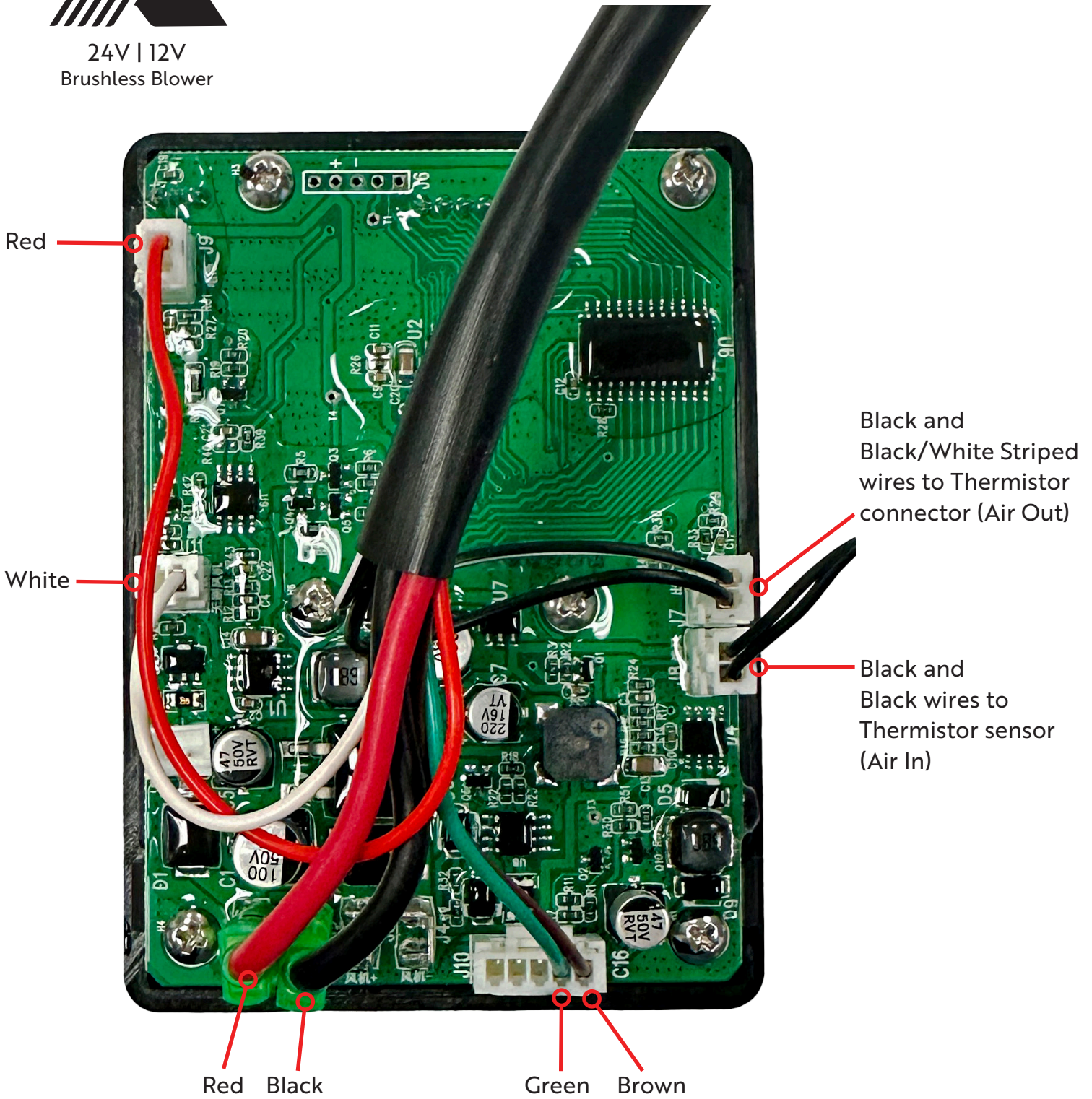

Red

White

Black and  
Black/White Striped  
wires to Thermistor  
connector (Air Out)

Black and  
Black wires to  
Thermistor sensor  
(Air In)

Red Black

Green Brown

Shown below is a properly wired Control Panel for X<sup>2</sup> 48V model with brushless blower.



48V  
Brushless Blower

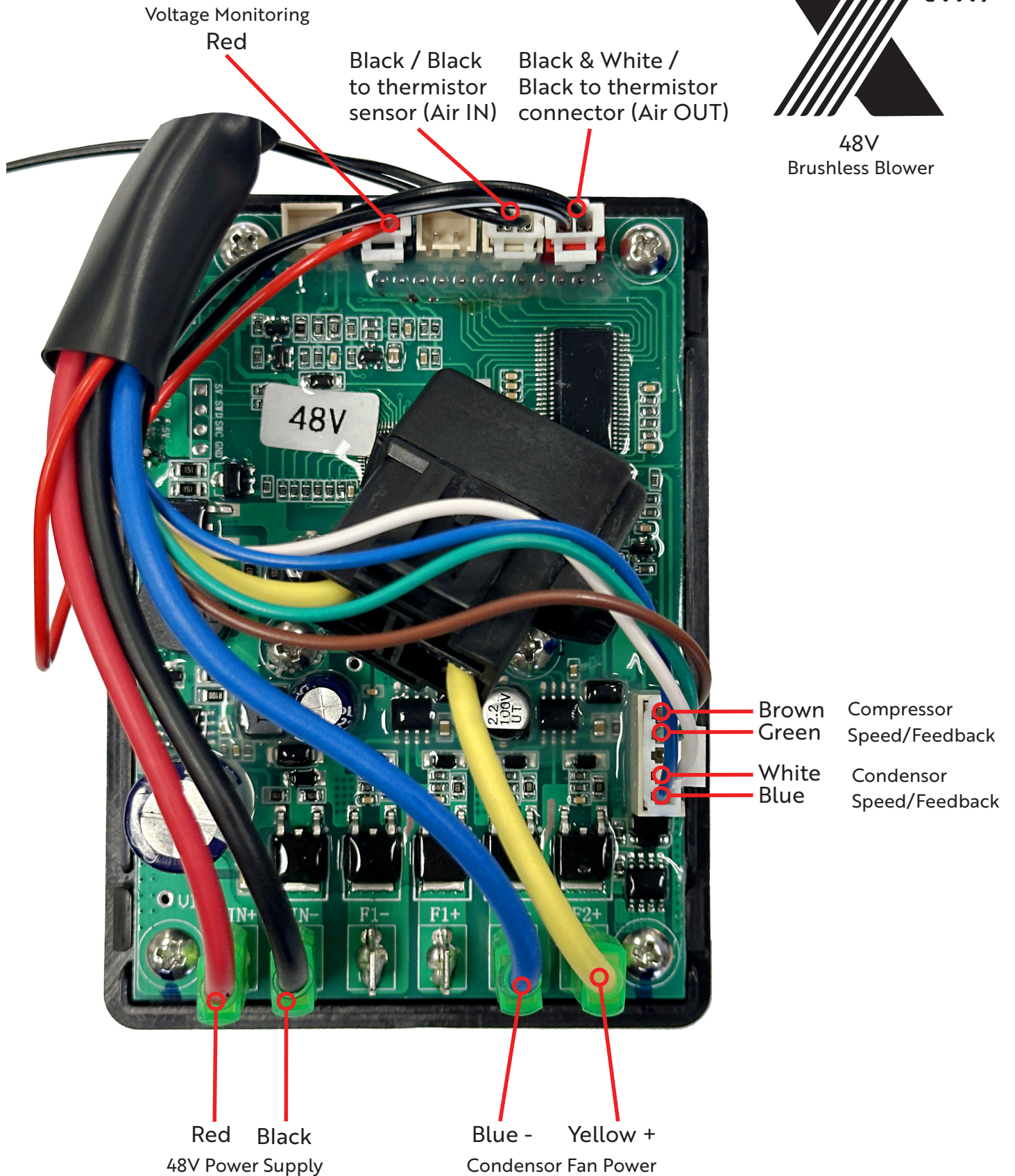



This is a properly wired LED Control Panel for the X<sup>2</sup> (24V and 12V) models with brushed fan.

(Electrical Schematic To Come)



24V | 12V  
Brushed Blower

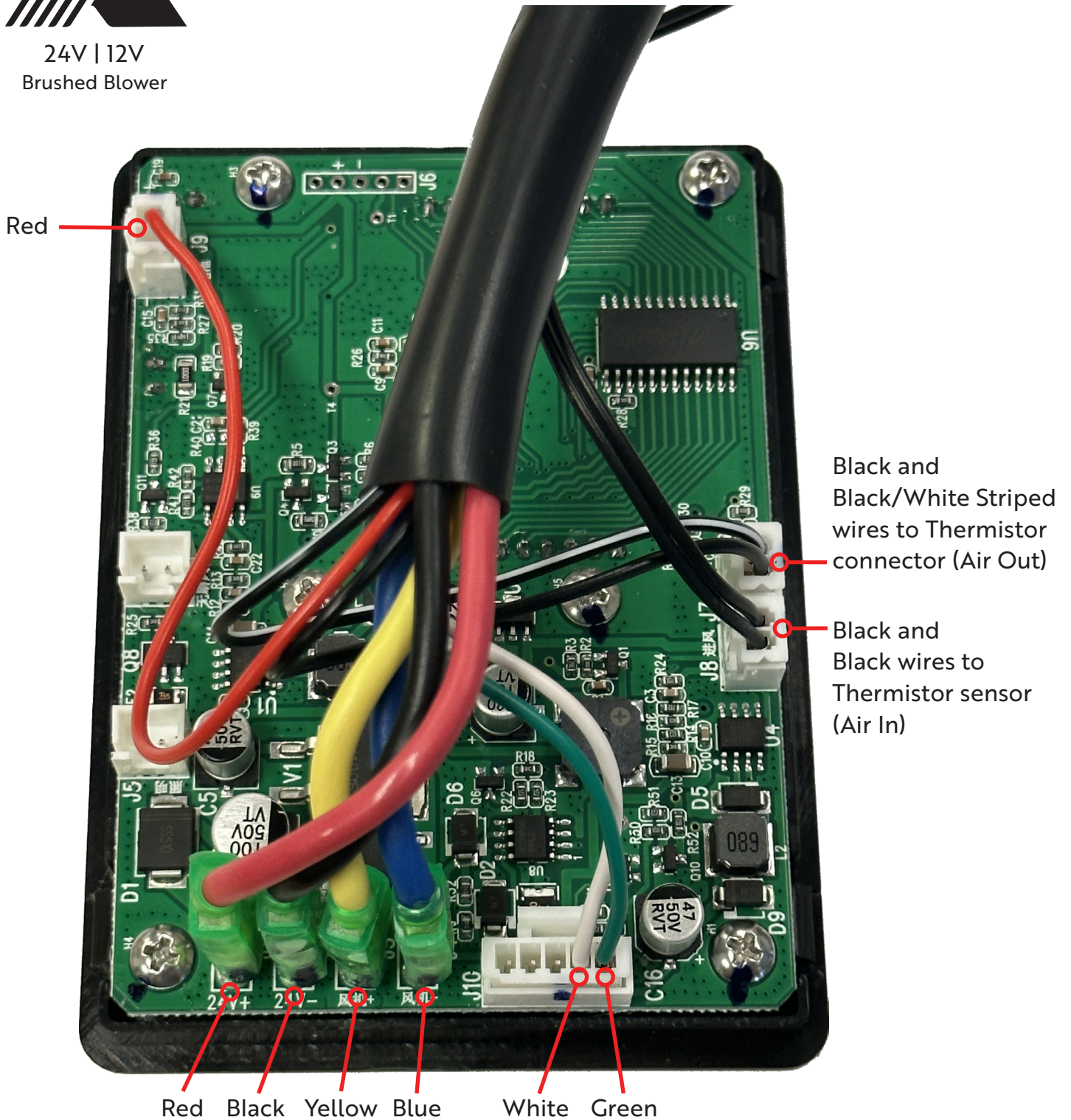

# Troubleshoot Common Issues

All of our AC units are bench tested before leaving the Nomadic Cooling warehouse. In the unfortunate event that your AC unit is not working properly, you should consider some of these more common problems that our technical support team encounter.

**1. Power issues.** Using a voltmeter, measure the voltage the AC unit is receiving from the power source. A drop in expected power will cause a drop in cooling capacity for the AC unit, just as it would cause a light bulb to not glow as brightly.

**A. If the voltage getting to the AC unit is low,** the first thing to consider is the distance from the power source to the AC unit. Voltage loss in wires increases as the distance grows. Our AC unit power cord specifications are conservative, but if the distance is greater than 15-20 feet, it may be necessary to use a thicker gauge wire.

If the wiring distance is not an issue, you can check the following:

**B. Check the fuse or breaker, and any other inline components between your power source and the AC unit.** Check the wiring connections to and from these components. Ensure that your fuse or breaker are properly set, inspect the wiring in and around such components for any cracks or looseness.

**C. Check the wires from your power source to your AC unit.** While running these wires through a vehicle's framework, it can be necessary to twist and wrap around obstacles, or feed them through narrow spaces, often with sharp edges exposed. This can result in damage to

the wires or insulation, which will cause a grounding or short, and a drop in amperage to the AC unit.

**2. Are the Crossbar Bolts too long for your needs?** Every build is different, and if you find that the crossbar bolts are too long, you can use a cold saw, bandsaw, grinder or hacksaw to trim them down to the length you need.



Remember to wear safety goggles.



Thread the nut before cutting the bolt and then use it to re-form the thread after cutting.

## If you need to contact technical support...

Every system is different, so it is extremely helpful (if not necessary) for our support team to have photos of your setup to help troubleshoot any problems. Please be prepared to take any photos that may be necessary to [support@nomadiccooling.com](mailto:support@nomadiccooling.com).

You can also initiate support requests by e-mailing [support@nomadiccooling.com](mailto:support@nomadiccooling.com). Or you can call (480) 576-2489. Our support team attempts to respond as soon as possible and we strive to always respond within 24 hours Monday through Friday.





## WARRANTY POLICY For X Series DC-Powered Rooftop AC Units

Nomadic Cooling is dedicated to delivering top-quality products coupled with outstanding customer service. We provide an industry-leading warranty for our products to ensure your satisfaction and peace of mind. Technical support is available for the lifetime of any X Series AC unit. Please review the following warranty policy.

### 1. Warranty Period

All X Series AC units are covered by a one year warranty period which begins on date of purchase. An optional one-year extended warranty is available if purchased prior to initial warranty period expiration. Note: X<sup>3</sup> AC units purchased prior to December 1, 2023 are covered by an initial two-year warranty.

### 2. Warranty Coverage

During the warranty period, the Nomadic Cooling Co Warranty will cover all X Series AC units that experience any defects due to manufacturing or workmanship issues. The customer shall be responsible for all shipping costs to get the X Series AC unit to and from Nomadic Cooling for inspection, repair, replacement or upgrade.

### 3. Optional Extended Warranty (X2 and X3)

You may purchase a one-year extended warranty for any X Series AC unit which provides the same coverage as described above (#2).

### 4. Optional Refundable Core Charge

If you wish to have a replacement X Series AC unit shipped prior to Nomadic Cooling receiving the warranted unit, a core charge of up to 50% of the Manufacturer's Suggested Retail Price (MSRP) may apply. This core charge is intended to ensure the return of the warranted unit to Nomadic Cooling. The core charge will be added to the purchase price of the replacement unit and is refunded upon Nomadic Cooling's receipt and evaluation of the returned unit. If the warranty department determines that a defect was due to Nomadic Cooling's fault, the core charge will be refunded in full.

### 5. Exclusions and Limitations

The following are not covered by the warranty:

- Damage caused by misuse, negligence, accidents, or unauthorized modifications.
- Damage resulting from improper installation, maintenance, or storage.
- Damage caused by natural disasters, fire, water, or any other external factors beyond our control.
- Normal wear and tear, cosmetic damages, or minor imperfections that do not affect the functionality of the product.
- Warranty, including an optional extended warranty, is non-transferable.

### 6. Labor Exclusion

Nomadic Cooling's warranty policy does not cover any labor costs associated with the inspection, repair, or replacement of an X Series AC unit. Any additional expenses related to labor, including but not limited to installation, removal, or troubleshooting, shall be the sole responsibility of the customer.

### 7. Warranty Claims

To initiate a warranty claim, please e-mail or call us. Our representatives will guide you through the necessary steps and provide instructions on how to proceed with the warranty claim.

Please note that this warranty policy is subject to the terms and conditions stated herein and may be subject to change without prior notice. Nomadic Cooling reserves the right to determine the validity of all warranty claims and to make the final decision regarding repairs, replacements, or refunds.

---

**For warranty claims, additional information  
or any questions, please contact us at:**

**Support@NomadicCooling.com  
or call us at (480) 576-2489.**

---

## RETURNS, CANCELLATIONS AND MISSING ITEMS

### Returns

Nomadic Cooling will gladly accept returns within 30 days of acceptance of order. Please e-mail [Info@NomadicCooling.com](mailto:Info@NomadicCooling.com) or call (480) 576-2489. Any returns after 30 days are subject to prior approval.

Only items in their original condition with all packaging, accessories, instruction manuals, warranty cards, and UPC codes will be accepted for return.

A 15% restocking fee will be assessed for all return orders. Customers are responsible for the cost of shipping of any product returned to Nomadic Cooling. We are happy to arrange for return shipping using our provider rates, or shipping can be arranged independently. Returns must include a tracking number.

If a returned product arrives at Nomadic Cooling with damage due to mishandling, poor packaging, or in otherwise unusable condition for resale, then an additional fee may be assessed.

Products should be returned to:

Nomadic Cooling Co  
16680 N 51st Ave Unit 4-5  
Glendale, AZ 85306

Due to some products being shipped directly from the manufacturer, please check with a Nomadic Cooling employee where to send all other returns.

Returned products will be assessed for damage upon receiving at Nomadic Cooling.

Refunds will not be processed until the product is received, inspected, and/or tested by Nomadic Cooling.

All refunds will be processed back to the original payment method and/or store credit.

### Order Cancellations

If you wish to cancel your order for any reason, please let us know as soon as possible. Please e-mail [Info@NomadicCooling.com](mailto:Info@NomadicCooling.com) or call (480) 576-2489.

If you are canceling before the order has been shipped, then we will process a refund back to the original payment method. If you are canceling after the order has been fulfilled, then the cancellation will be processed as a return and is subject the restocking fee and shipping costs. If applicable, you will be responsible for any "stop and return" fees.

### Missing Items

Upon receiving your order from Nomadic Cooling, please immediately open the package and inspect the contents to ensure all items from the order have been included. If you suspect that an item is missing or the incorrect item was sent, please notify a Nomadic Cooling employee ASAP so we can assess the order. If you fail to notify Nomadic Cooling within 14 days of accepting an order with missing or incorrect items, then you will be responsible for shipping costs for the missing or incorrect item(s).

To better prevent orders with missing or duplicate items, and for ease of tracking, Nomadic Cooling will only be shipping orders once all items in the order are ready for shipping. Nomadic Cooling will not send partial shipments. Exceptions may occur when specifically requested by the customer and/or item(s) in the order are on backorder. Products are shipped the same day they are packaged and ready, unless requested otherwise.